

Pressure booster sets

Product Catalogue



Quick selection table

for variable speed units with two electric pumps

SELECTION TABLE FOR VARIABLE SPEED UNITS

Flats: 2 bathrooms + kitchen	Max flow rate		Building floors	Pressure	Variable speed [electric pump type]							
	[no.]	[lit/min]			[m³/h]	[no.]	[m]	COMPACT	HP	MATRIX	HP	CVM
from 2 to 6	90	5.5	2	31	2GPE COMPACT A/10	1	2GPE MATRIX 3-4T	0.9	2GPE CVM A/10	1	2GPE EVMSG3 8N5	1
			3	35	2GPE COMPACT A/10	1	2GPE MATRIX 3-5T	1	2GPE CVM A/10	1	2GPE EVMSG3 8N5	1
			4	40	2GPE COMPACT A/10	1	2GPE MATRIX 3-6T	1.2	2GPE CVM A/10	1	2GPE EVMSG3 8N5	1
			5	43	2GPE COMPACT A/12	1.2	2GPE MATRIX 3-6T	1.2	2GPE CVM A/12	1.2	2GPE EVMSG3 8N5	1
			6	46	2GPE COMPACT A/12	1.2	2GPE MATRIX 3-6T	1.2	2GPE CVM A/12	1.2	2GPE EVMSG3 8N5	1
from 7 to 10	120	7	2	31	2GPE COMPACT A/10	1	2GPE MATRIX 3-5T	1	2GPE CVM A/10	1	2GPE EVMSG3 8N5	1
			3	35	2GPE COMPACT A/12	1.2	2GPE MATRIX 3-6T	1.2	2GPE CVM A/12	1.2	2GPE EVMSG3 8N5	1
			4	40	2GPE COMPACT A/12	1.2	2GPE MATRIX 3-7T	1.8	2GPE CVM B/12	1.2	2GPE EVMSG3 8N5	1
			5	43	2GPE COMPACT B/15	1.5	2GPE MATRIX 3-8T	1.8	2GPE CVM B/15	1.5	2GPE EVMSG3 9N5	1.5
			6	46	2GPE COMPACT B/15	1.5	2GPE MATRIX 3-8T	1.8	2GPE CVM B/15	1.5	2GPE EVMSG3 9N5	1.5
from 11 to 15	150	9	2	31	2GPE COMPACT B/12	1.2	2GPE MATRIX 5-4T	1.2	2GPE CVM B/12	1.2	2GPE EVMSG5 5N5	1.5
			3	35	2GPE COMPACT B/12	1.2	2GPE MATRIX 5-5T	1.8	2GPE CVM B/12	1.2	2GPE EVMSG5 5N5	1.5
			4	40	2GPE COMPACT B/15	1.5	2GPE MATRIX 5-5T	1.8	2GPE CVM B/15	1.5	2GPE EVMSG5 7N5	2
			5	43	2GPE COMPACT B/15	1.5	2GPE MATRIX 5-6T	1.8	2GPE CVM B/15	1.5	2GPE EVMSG5 7N5	2
			6	46	2GPE COMPACT B/15	1.5	2GPE MATRIX 5-6T	1.8	2GPE CVM B/15	1.5	2GPE EVMSG5 7N5	2
from 16 to 20	175	10.5	2	31	2GPE COMPACT B/15	1.5	2GPE MATRIX 5-5T	1.8	2GPE CVM B/15	1.5	2GPE EVMSG5 5N5	1.5
			3	35	2GPE COMPACT B/15	1.5	2GPE MATRIX 5-5T	1.8	2GPE CVM B/15	1.5	2GPE EVMSG5 7N5	2
			4	40	2GPE COMPACT B/15	1.5	2GPE MATRIX 5-6T	1.8	2GPE CVM B/20	2	2GPE EVMSG5 7N5	2
			5	43			2GPE MATRIX 5-7T	2	2GPE CVM B/23	2.3	2GPE EVMSG5 7N5	2
			6	46			2GPE MATRIX 5-7T	2	2GPE CVM B/23	2.3	2GPE EVMSG5 7N5	2
from 21 to 30	200	12	2	31	2GPE COMPACT B/15	1.5	2GPE MATRIX 5-5T	1.8	2GPE CVM B/15	1.5	2GPE EVMSG5 5N5	1.5
			3	35			2GPE MATRIX 5-5T	1.8	2GPE CVM B/15	1.5	2GPE EVMSG5 7N5	2
			4	40			2GPE MATRIX 5-6T	1.8	2GPE CVM B/20	2	2GPE EVMSG5 7N5	2
			5	43			2GPE MATRIX 5-7T	2	2GPE CVM B/23	2.3	2GPE EVMSG5 7N5	2
			6	46			2GPE MATRIX 5-7T	2	2GPE CVM B/23	2.3	2GPE EVMSG5 7N5	2
from 31 to 40	240	14.5	2	31			2GPE MATRIX 10-4T	2			2GPE EVMSG5 7N5	2
			3	35			2GPE MATRIX 10-4T	2			2GPE EVMSG10 6N5	3
			4	40			2GPE MATRIX 10-5T	3			2GPE EVMSG10 6N5	3
			5	43			2GPE MATRIX 10-5T	3			2GPE EVMSG10 6N5	3
			6	46			2GPE MATRIX 10-6T	3			2GPE EVMSG10 6N5	3
from 41 to 50	270	16	2	31			2GPE MATRIX 10-4T	2			2GPE EVMSG10 6N5	3
			3	35			2GPE MATRIX 10-4T	2			2GPE EVMSG10 6N5	3
			4	40			2GPE MATRIX 10-5T	3			2GPE EVMSG10 6N5	3
			5	43			2GPE MATRIX 10-6T	3			2GPE EVMSG10 6N5	3
			6	46			2GPE MATRIX 10-6T	3			2GPE EVMSG10 6N5	3
from 51 to 70	310	18.5	2	31			2GPE MATRIX 10-5T	3			2GPE EVMSG10 6N5	3
			3	35			2GPE MATRIX 10-5T	3			2GPE EVMSG10 6N5	3
			4	40			2GPE MATRIX 10-6T	3			2GPE EVMSG10 6N5	3
			5	43			2GPE MATRIX 10-6T	3			2GPE EVMSG10 6N5	3
			6	46			2GPE MATRIX 10-6T	3			2GPE EVMSG10 6N5	3

Table valid for new installations with unit located on the ground floor, near the consumption points;
for installation in a basement or garage, add an extra floor when making the choice.

Quick selection table

for fixed speed units with two electric pumps

SELECTION TABLE FOR FIXED SPEED UNITS

Flats: 2 bathrooms + kitchen [no.]	Max flow rate [lit/min] [m³/h]		Building floors [no.]	Pressure [m]	Fixed speed [electric pump type]													
					AGA	HP	CDA	HP	2CDX	HP	COMPACT	HP	MATRIX	HP	CVM	HP	EVMSG	HP
from 2 to 6	90	5.5	2	31	2GP AGA 1.50	1.5	2GP CDA 1.00	1	2GP 2CDX 70/10	1	2GP COMPACT A/8	0.8	2GP MATRIX 3-4T	0.9	2GP CVM A/8	0.8		
			3	35	2GP AGA 1.50	1.5	2GP CDA 1.00	1	2GP 2CDX 70/12	1.2	2GP COMPACT A/10	1	2GP MATRIX 3-5T	1	2GP CVM A/10	1	2GP EVMSG3 7N5	1
			4	40	2GP AGA 1.50	1.5	2GP CDA 1.50	1.5	2GP 2CDX 70/15	1.5	2GP COMPACT A/10	1	2GP MATRIX 3-5T	1	2GP CVM A/10	1	2GP EVMSG3 7N5	1
			5	43	2GP AGA 2.00	2	2GP CDA 1.50	1.5	2GP 2CDX 70/15	1.5	2GP COMPACT A/10	1	2GP MATRIX 3-6T	1.2	2GP CVM A/10	1	2GP EVMSG3 8N5	1
			6	46	2GP AGA 2.00	2	2GP CDA 1.50	1.5	2GP 2CDX 70/15	1.5	2GP COMPACT A/10	1	2GP MATRIX 3-6T	1.2	2GP CVM A/10	1	2GP EVMSG3 8N5	1
from 7 to 10	120	7	2	31	2GP AGA 1.50	1.5	2GP CDA 1.00	1	2GP 2CDX 70/10	1	2GP COMPACT A/10	1	2GP MATRIX 3-5T	1	2GP CVM A/10	1	2GP EVMSG3 7N5	1
			3	35	2GP AGA 1.50	1.5	2GP CDA 1.50	1.5	2GP 2CDX 70/12	1.2	2GP COMPACT A/10	1	2GP MATRIX 3-6T	1.2	2GP CVM A/10	1	2GP EVMSG3 7N5	1
			4	40	2GP AGA 2.00	2	2GP CDA 1.50	1.5	2GP 2CDX 70/15	1.5	2GP COMPACT A/12	1.2	2GP MATRIX 3-6T	1.2	2GP CVM A/12	1.2	2GP EVMSG3 8N5	1
			5	43	2GP AGA 2.00	2	2GP CDA 1.50	1.5	2GP 2CDX 70/15	1.5	2GP COMPACT A/12	1.2	2GP MATRIX 3-7T	1.8	2GP CVM A/12	1.2	2GP EVMSG3 8N5	1
			6	46	2GP AGA 3.00	3	2GP CDA 2.00	2	2GP 2CDX 70/20	2	2GP COMPACT A/12	1.2	2GP MATRIX 3-7T	1.8	2GP CVM A/12	1.2	2GP EVMSG3 9N5	1.5
from 11 to 15	150	9	2	31	2GP AGA 1.50	1.5	2GP CDA 1.50	1.5	2GP 2CDX 120/15	1.5	2GP COMPACT B/12	1.2	2GP MATRIX 5-4T	1.2	2GP CVM A/10	1	2GP EVMSG5 5N5	1.5
			3	35	2GP AGA 2.00	2	2GP CDA 1.50	1.5	2GP 2CDX 120/15	1.5	2GP COMPACT B/12	1.2	2GP MATRIX 5-4T	1.2	2GP CVM A/12	1.2	2GP EVMSG5 5N5	1.5
			4	40	2GP AGA 3.00	3	2GP CDA 1.50	1.5	2GP 2CDX 120/15	1.5	2GP COMPACT B/15	1.5	2GP MATRIX 5-5T	1.8	2GP CVM B/12	1.2	2GP EVMSG5 5N5	1.5
			5	43	2GP AGA 3.00	3	2GP CDA 2.00	2	2GP 2CDX120/20	2	2GP COMPACT B/15	1.5	2GP MATRIX 5-5T	1.8	2GP CVM B/12	1.2	2GP EVMSG5 7N5	2
			6	46	2GP AGA 3.00	3	2GP CDA 2.00	2	2GP 2CDX120/20	2	2GP COMPACT B/15	1.5	2GP MATRIX 5-5T	1.8	2GP CVM B/15	1.5	2GP EVMSG5 7N5	2
from 16 to 20	175	10.5	2	31	2GP AGA 2.00	2	2GP CDA 1.50	1.5	2GP 2CDX 120/15	1.5	2GP COMPACT B/12	1.2	2GP MATRIX 5-5T	1.8	2GP CVM B/12	1.2	2GP EVMSG5 5N5	1.5
			3	35	2GP AGA 3.00	3	2GP CDA 2.00	2	2GP 2CDX 120/15	1.5	2GP COMPACT B/15	1.5	2GP MATRIX 5-5T	1.8	2GP CVM B/15	1.5	2GP EVMSG5 5N5	1.5
			4	40	2GP AGA 3.00	3	2GP CDA 2.00	2	2GP 2CDX 120/20	2	2GP COMPACT B/15	1.5	2GP MATRIX 5-5T	1.8	2GP CVM B/15	1.5	2GP EVMSG5 7N5	2
			5	43			2GP CDA 2.00	2	2GP 2CDX 120/20	2			2GP MATRIX 5-6T	1.8	2GP CVM B/20	2	2GP EVMSG5 7N5	2
			6	46			2GP CDA 2.00	2	2GP 2CDX 120/20	2			2GP MATRIX 5-6T	1.8	2GP CVM B/20	2	2GP EVMSG5 7N5	2
from 21 to 30	200	12	2	31			2GP CDA 2.00	2	2GP 2CDX 120/15	1.5	2GP COMPACT B/15	1.5	2GP MATRIX 5-5T	1.8	2GP CVM B/15	1.5	2GP EVMSG5 5N5	1.5
			3	35			2GP CDA 2.00	2	2GP 2CDX 120/15	1.5	2GP COMPACT B/15	1.5	2GP MATRIX 5-5T	1.8	2GP CVM B/15	1.5	2GP EVMSG5 7N5	2
			4	40			2GP CDA 2.00	2	2GP 2CDX120/20	2			2GP MATRIX 5-6T	1.8	2GP CVM B/20	2	2GP EVMSG5 7N5	2
			5	43			2GP CDA 3.00	3	2GP 2CDX120/20	2			2GP MATRIX 5-6T	1.8	2GP CVM B/20	2	2GP EVMSG5 7N5	2
			6	46			2GP CDA 3.00	3	2GP 2CDX120/30	3			2GP MATRIX 5-7T	2	2GP CVM B/23	2.3	2GP EVMSG5 7N5	2
from 31 to 40	240	14.5	2	31			2GP CDA 3.00	3	2GP 2CDX 120/15	1.5			2GP MATRIX 10-4T	2			2GP EVMSG5 7N5	2
			3	35			2GP CDA 3.00	3	2GP 2CDX 120/15	1.5			2GP MATRIX 10-4T	2			2GP EVMSG5 7N5	2
			4	40			2GP CDA 3.00	3	2GP 2CDX120/20	2			2GP MATRIX 10-5T	3			2GP EVMSG5 7N5	2
			5	43					2GP 2CDX 120/30	3			2GP MATRIX 10-5T	3			2GP EVMSG5 8N5	3
			6	46					2GP 2CDX 120/30	3			2GP MATRIX 10-5T	3			2GP EVMSG5 8N5	3
from 41 to 50	270	16	2	31					2GP 2CDX 120/15	1.5			2GP MATRIX 10-4T	2			2GP EVMSG10 6N5	3
			3	35					2GP 2CDX 120/15	1.5			2GP MATRIX 10-4T	2			2GP EVMSG10 6N5	3
			4	40					2GP 2CDX120/20	2			2GP MATRIX 10-5T	3			2GP EVMSG10 6N5	3
			5	43					2GP 2CDX 120/30	3			2GP MATRIX 10-5T	3			2GP EVMSG10 6N5	3
			6	46					2GP 2CDX 120/30	3			2GP MATRIX 10-5T	3			2GP EVMSG10 6N5	3
from 51 to 70	310	18.5	2	31					2GP 2CDX 200/30	3			2GP MATRIX 10-4T	2			2GP EVMSG10 6N5	3
			3	35					2GP 2CDX 200/30	3			2GP MATRIX 10-4T	2			2GP EVMSG10 6N5	3
			4	40					2GP 2CDX 200/30	3			2GP MATRIX 10-5T	3			2GP EVMSG10 6N5	3
			5	43					2GP 2CDX 200/30	3			2GP MATRIX 10-5T	3			2GP EVMSG10 6N5	3
			6	46					2GP 2CDX 200/30	3			2GP MATRIX 10-6T	3			2GP EVMSG10 6N5	3

Table valid for new installations with unit located on the ground floor, near the consumption points;
for installation in a basement or garage, add an extra floor when making the choice.

Contents

SELECTION TABLE FOR FIXED SPEED UNITS

2GP AGA - Pressure booster sets consisting of two self-priming electric pumps in cast iron	8
2GP CDA - Pressure booster sets consisting of two twin-impeller electric pumps in cast iron	10
2GP CDX - Pressure booster sets consisting of two twin-impeller electric pumps in AISI 304 stainless steel	12
2GP COMPACT - Pressure booster sets consisting of two multi-stage horizontal electric pumps with technopolymer impellers and cast iron body	14
2GP MATRIX - Pressure booster sets consisting of two multi-stage horizontal electric pumps in AISI 304 stainless steel	16
2GP CVM - Pressure booster sets consisting of two multi-stage vertical electric pumps with technopolymer impellers and cast iron body	18
2GP EVMSG - Pressure booster sets consisting of two multi-stage vertical electric pumps in AISI 304 stainless steel with a cast iron body	20
3GP EVMSG - Pressure booster sets consisting of three multi-stage vertical electric pumps in AISI 304 stainless steel with a cast iron body	22

SELECTION TABLE FOR VARIABLE SPEED UNITS

1GPE JEX - Pressure booster sets consisting of a self-priming electric pump in stainless steel with a technopolymer impeller	26
1GPE MATRIX - Pressure booster sets consisting of a multi-stage horizontal electric pump in AISI 304 stainless steel	28
2GPE COMPACT - Pressure booster sets consisting of two multi-stage horizontal electric pumps with technopolymer impellers and cast iron body	30
2GPE MATRIX - Pressure booster sets consisting of two multi-stage horizontal electric pumps in AISI 304 stainless steel	32
2GPE CVM - Pressure booster sets consisting of two multi-stage vertical electric pumps with technopolymer impellers and cast iron body	34
2GPE EVMSG - Pressure booster sets consisting of two multi-stage vertical electric pumps in AISI 304 stainless steel with a cast iron body	36
3GPE EVMSG - Pressure booster sets consisting of three multi-stage vertical electric pumps in AISI 304 stainless steel with a cast iron body	38

CONTROL PANELS AND SYSTEMS

EP-PRO - Fixed speed electronic panels with direct start-up, controlled by a 4-20mA pressure sensor	42
EP-PRO SD - Fixed speed electronic panels with star/triangle start-up, controlled by a 4-20mA pressure sensor	43
SP-EFC RANGE - Variable frequency panels with single built-in exchange inverter	44
SP-MFC RANGE - Variable frequency panels with a built-in inverter for every pump	45
E-SPD+ - Variable frequency control device installed on the motor	46

OPTIONALS

AVAILABLE UPON REQUEST - Valves, air supply units, floats, expansion tanks and alarm indicators	47
--	-----------

TECHNICAL INFORMATION

EVERYTHING YOU NEED TO KNOW ABOUT OUR PRESSURE BOOSTER SETS AND THEIR CONTROL SYSTEMS	50
--	-----------



Unit	General characteristics	Versions available					Page
GP AGA 	<p>▲ 68 m</p> <p>12 m³/h</p> <p>Pressure booster sets consisting of two self-priming electric pumps in cast iron</p>	2 fixed speed pumps	●	●		●	8
GP CDA 	<p>▲ 76.5 m</p> <p>25.2 m³/h</p> <p>Pressure booster sets consisting of two twin-impeller electric pumps in cast iron</p>	2 fixed speed pumps	●	●		●	10
GP 2CDX 	<p>▲ 71.5 m</p> <p>25.2 m³/h</p> <p>Pressure booster sets consisting of two twin-impeller electric pumps in AISI 304 stainless steel</p>	2 fixed speed pumps	●	●	●	●	12
GP-GPE COMPACT 	<p>▲ 79 m</p> <p>14.4 m³/h</p> <p>Pressure booster sets consisting of two multi-stage horizontal electric pumps with technopolymer impellers and cast iron body</p>	2 fixed speed pumps	●	●		●	14
		2 variable speed pumps	●	●		●	30
GP-GPE MATRIX 	<p>▲ 97 m</p> <p>54 m³/h</p> <p>Pressure booster sets consisting of one or two multi-stage horizontal electric pumps in AISI 304 stainless steel.</p>	1 variable speed pump	●		●		28
		2 fixed speed pumps	●	●	●	●	16
		2 variable speed pumps	●	●	●	●	32
GP-GPE CVM 	<p>▲ 98.5 m</p> <p>14.4 m³/h</p> <p>Pressure booster sets consisting of two multi-stage vertical electric pumps with technopolymer impellers and cast iron body</p>	2 fixed speed pumps	●	●		●	18
		2 variable speed pumps	●	●		●	34
GP-GPE EVMSG 	<p>▲ 95.5 m</p> <p>120 m³/h</p> <p>Pressure booster sets consisting of two or three multi-stage vertical electric pumps in AISI 304 stainless steel with a cast iron body</p>	2 fixed speed pumps	●	●	●	●	20
		3 fixed speed pumps	●	●	●	●	22
		2 variable speed pumps	●	●	●	●	36
		3 variable speed pumps	●	●	●	●	38

Fixed speed units



2GP AGA

FIXED SPEED UNITS WITH TWO ELECTRIC PUMPS



Pressure booster sets consisting of 2 self-priming electric pumps in cast iron, designed for connection to membrane or air cushion pressure tanks or to autoclave systems. Particularly suitable for domestic water supply, distribution networks related to the building service sector, water supply for industry in general, irrigation of gardens, parks and sports fields, and clean water movement in general.

The 2GP AGA units are available in 230V single-phase and 400V three-phase versions.

IDENTIFICATION CODE

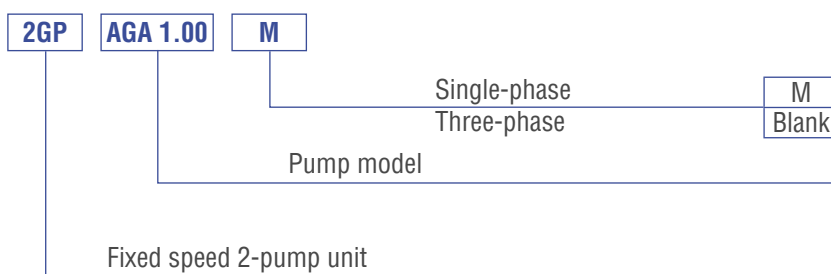

TECHNICAL DATA

Maximum working pressure	6 bar for 2GP AGA 1.00 10 bar for the other models
Maximum liquid temperature	45°C
Electric motor in insulation class	F
Efficiency	IE2 for single phase IE3 for three phase
Protection degree	IP44
Supply voltage	230V ± 10% (single-phase versions) 400V ± 10% (three-phase versions)

2GP AGA

FIXED SPEED UNITS WITH TWO ELECTRIC PUMPS

Modello	HP	kW	Q=Portata										Corr. Ass.		DNA	DNM
			l/min	0	10	20	60	90	100	120	160	200	[A]			
			m ³ /h	0	0,6	1,2	3,6	5,4	6	7,2	9,6	12	230V	400V		
			H=Prevalenza [m]										2x	2x		
2GP AGA 1,00M	1	0,75		50	47,5	45	35,7	29,1	27	23	-	-	4,4	-	G1½	G1½
2GP AGA 1,50M	2	1,5		51	-	48	42,4	38,6	37,4	35,1	30,8	27	9	-	G2½	G1½
2GP AGA 2,00M	2	1,5		62,5	-	59	52,2	47,3	45,7	42,5	36,4	30,5	9	-	G2½	G1½
2GP AGA 1,00	1	0,75		50	47,5	45	35,7	29,1	27	23	-	-	-	1,7	G1½	G1½
2GP AGA 1,50	1,5	1,1		51	-	48	42,4	38,6	37,4	35,1	30,8	27	-	3,3	G2½	G1½
2GP AGA 2,00	2	1,5		62,5	-	59	52,2	47,3	45,7	42,5	36,4	30,5	-	3,6	G2½	G1½
2GP AGA 3,00	3	2,2		72	-	68	60,8	55,9	54,4	51,6	46,4	42	-	4,7	G2½	G1½

SPECIFICATIONS

Pressure booster unit consisting of 2 self-priming centrifugal pumps in cast iron, AGA range, installed on their own galvanised steel base (with omega profile) and controlled via an electronic panel with alternating exchange at every start-up. The pumps are joined together by means of an intake manifold and a delivery manifold, both in AISI 304 stainless steel.

The unit is completed with 4 brass shut-off valves (2 on the intake side and 2 on the delivery side), 2 brass check valves (on the intake side), 2 brass connectors for the air supply, 1 pressure transducer (4-20mA) and 1 analogue pressure gauge. The unit is factory tested and assembled prior to consignment.

SEE ALL THE OPTIONALS ON PAGE 47

2GP CDA

FIXED SPEED UNITS WITH TWO ELECTRIC PUMPS



Pressure booster sets consisting of 2 centrifugal twin-impeller electric pumps in cast iron, designed for connection to membrane or air cushion pressure tanks or to autoclave systems. Particularly suitable for domestic water supply, distribution networks related to the building service sector, water supply for industry in general, irrigation of gardens, parks and sports fields, and clean water movement in general.

The 2GP CDA units are available in 230V single-phase and 400V three-phase versions.

IDENTIFICATION CODE

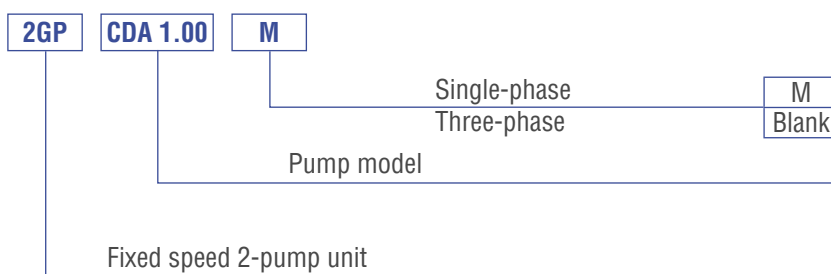

TECHNICAL DATA

Maximum working pressure	6 bar for 2GP CDA 1.00 10 bar for the other models
Maximum liquid temperature	40/80°C (depending on the pump model)
Electric motor in insulation class	F
Efficiency	IE2 for single phase IE3 for three phase
Protection degree	IP44
Supply voltage	230V ± 10% (single-phase versions) 400V ± 10% (three-phase versions)

2GP CDA

FIXED SPEED UNITS WITH TWO ELECTRIC PUMPS

Modello	HP	kW	Q=Portata													Corr. Ass. [A]		DNA	DNM
			l/min	0	40	80	100	160	180	200	220	280	340	380	420	230V	400V		
			m ³ /h	0	2,4	4,8	6	9,6	10,8	12	13,2	16,8	20,4	22,8	25,2				
			H=Prevalenza [m]													2x	2x		
2GP CDA 1,00M	1,2	0,9	41,5	39,5	37	35,2	27	21	-	-	-	-	-	-	-	5,4	-	G1½	G1½
2GP CDA 1,50M	2	1,5	52	50,8	48,8	47,1	38,4	33,4	27,5	-	-	-	-	-	9	-	G2	G1½	
2GP CDA 2,00M	2	1,5	62	60,5	58,6	56,9	49,8	46,5	40,3	32,5	-	-	-	-	9	-	G2	G1½	
2GP CDA 1,00	1	0,75	41,5	39,5	37	35,2	27	21	-	-	-	-	-	-	-	1,7	G1½	G1½	
2GP CDA 1,50	1,5	1,1	52	50,8	48,8	47,1	38,4	33,4	27,5	-	-	-	-	-	3,3	G2	G1½		
2GP CDA 2,00	2	1,5	62	60,5	58,6	56,9	49,8	46,5	40,3	32,5	-	-	-	-	4,1	G2	G1½		
2GP CDA 3,00	3	2,2	64	-	60,5	59,3	54,1	51,6	48,4	44,6	32	-	-	-	4,7	G2	G2		
2GP CDA 4,00	4	3	70	-	-	67	64,8	63,9	62,5	62	58	53,5	48	-	6,4	G2½	G2		
2GP CDA 5,50	5,5	4	80	-	-	76,5	73,9	72,9	71,8	70,5	66,8	62	58,3	54	8,7	G2½	G2		

SPECIFICATIONS

Pressure booster unit consisting of 2 centrifugal twin-impeller pumps in cast iron, CDA range, installed on their own galvanised steel base (with omega profile) and controlled via an electronic panel with alternating exchange at every start-up. The pumps are joined together by means of an intake manifold and a delivery manifold, both in AISI 304 stainless steel.

The unit is completed with 4 brass shut-off valves (2 on the intake side and 2 on the delivery side), 2 brass check valves (on the intake side), 2 brass connectors for the air supply, 1 pressure transducer (4-20mA) and 1 analogue pressure gauge. The unit is factory tested and assembled prior to consignment.

SEE ALL THE OPTIONALS ON PAGE 47

2GP 2CDX

FIXED SPEED UNITS WITH TWO ELECTRIC PUMPS



Pressure booster sets consisting of 2 centrifugal twin-impeller electric pumps in AISI 304 stainless steel, designed for connection to membrane or air cushion pressure tanks or to autoclave systems. Particularly suitable for domestic water supply, distribution networks related to the building service sector, water supply for industry in general, irrigation of gardens, parks and sports fields, and clean water movement in general.

The 2GP 2CDX units are available in 230V single-phase and 400V three-phase versions.

IDENTIFICATION CODE

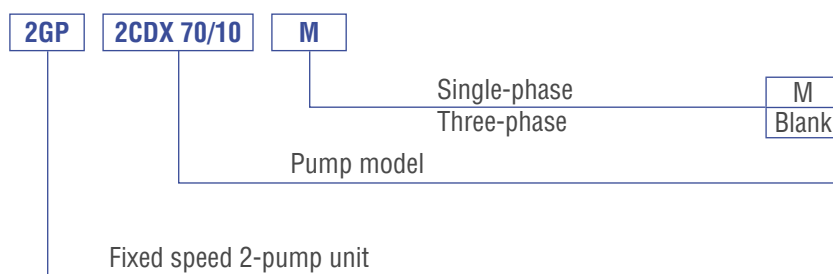

TECHNICAL DATA

Maximum working pressure	8 bar
Maximum liquid temperature	60°C
Electric motor in insulation class	F
Efficiency	IE2 for single phase IE3 for three phase
Protection degree	IP55
Supply voltage	230V ± 10% (single-phase versions) 400V ± 10% (three-phase versions)

2GP 2CDX

FIXED SPEED UNITS WITH TWO ELECTRIC PUMPS

Modello	HP	kW	Q=Portata										Corr. Ass.		DNA	DNM
			l/min	0	40	80	120	160	240	300	360	420	[A]			
			m ³ /h	0	2,4	4,8	7,2	9,6	14,4	18	21,6	25,2	230V	400V		
			H=Prevalenza [m]										2x	2x		
2GP 2CDX 70/10M	1,2	0,9		41	38,5	35,3	31,5	27	-	-	-	-	5,4	-	G2	G1½
2GP 2CDX 70/12M	1,2	0,9		48	44,5	40,3	35,5	30	-	-	-	-	5,4	-	G2	G1½
2GP 2CDX 70/15M	2	1,5		56	52,5	48	42,8	36,5	-	-	-	-	9	-	G2	G1½
2GP 2CDX 70/20M	2	1,5		64	60	55,6	50,4	44	-	-	-	-	9	-	G2	G1½
2GP 2CDX 120/15M	2	1,5		46	-	42	41	39,5	35	30	-	-	9	-	G2	G2
2GP 2CDX 120/20M	2	1,5		55	-	51,5	49,5	47,4	41,8	36,5	-	-	9	-	G2	G2
2GP 2CDX 70/10	1	0,75		41	38,5	35,3	31,5	27	-	-	-	-	-	2	G2	G1½
2GP 2CDX 70/12	1,2	0,9		48	44,5	40,3	35,5	30	-	-	-	-	-	2,5	G2	G1½
2GP 2CDX 70/15	1,5	1,1		56	52,5	48	42,8	36,5	-	-	-	-	-	3,3	G2	G1½
2GP 2CDX 70/20	2	1,5		64	60	55,6	50,4	44	-	-	-	-	-	4,5	G2	G1½
2GP 2CDX 120/15	1,5	1,1		46	-	42	41	39,5	35	30	-	-	-	3,3	G2	G2
2GP 2CDX 120/20	2	1,5		55	-	51,5	49,5	47,4	41,8	36,5	-	-	-	4,5	G2	G2
2GP 2CDX 120/30	3	2,2		63	-	59	57	54,6	49,2	44	-	-	-	4,7	G2	G2
2GP 2CDX 120/40	4	3		71,5	-	68,5	66,5	64	58	52	-	-	-	6,4	G2	G2
2GP 2CDX 200/30	3	2,2		55	-	-	52	50,8	48,1	45,5	42,7	39,5	-	6,4	G2½	G2
2GP 2CDX 200/40	4	3		66	-	-	62,5	61,1	58	55,2	52,3	49	-	6,5	G2½	G2
2GP 2CDX 200/50	5,35	4		75	-	-	71,5	70,1	67	64,3	61,2	57,5	-	8,7	G2½	G2

SPECIFICATIONS

Pressure booster unit consisting of 2 centrifugal twin-impeller pumps in AISI 304 stainless steel, 2CDX range, installed on their own galvanised steel base (with omega profile) and controlled via an electronic panel with alternating exchange at every start-up. The pumps are joined together by means of an intake manifold and a delivery manifold, both in AISI 304 stainless steel. The unit is completed with 4 brass shut-off valves (2 on the intake side and 2 on the delivery side), 2 brass check valves (on the intake side), 2 brass connectors for the air supply, 1 pressure transducer (4-20mA) and 1 analogue pressure gauge. The unit is factory tested and assembled prior to consignment.

SEE ALL THE OPTIONALS ON PAGE 47

2GP COMPACT

FIXED SPEED UNITS WITH TWO ELECTRIC PUMPS



Pressure booster sets consisting of 2 centrifugal multi-stage electric pumps with technopolymer impellers and a cast iron body, designed for connection to membrane or air cushion pressure tanks or to autoclave systems. Particularly suitable for domestic water supply, distribution networks related to the building service sector, water supply for industry in general, irrigation of gardens, parks and sports fields, and clean water movement in general.

The 2GP COMPACT units are available in 230V single-phase and 400V three-phase versions.

IDENTIFICATION CODE

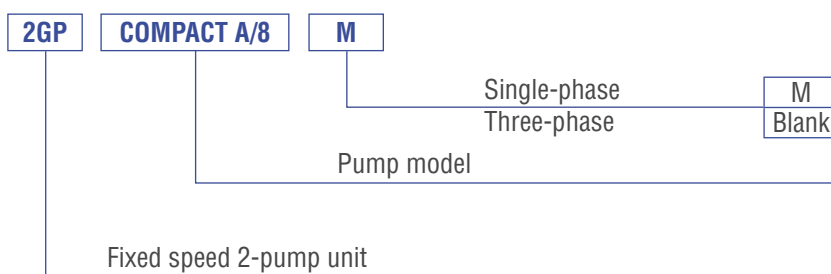

TECHNICAL DATA

Maximum working pressure	10 bar
Maximum liquid temperature	40°C
Electric motor in insulation class	F
Efficiency	IE2 for single phase IE3 for three phase
Protection degree	IP44
Supply voltage	230V ± 10% (single-phase versions) 400V ± 10% (three-phase versions)

2GP COMPACT

FIXED SPEED UNITS WITH TWO ELECTRIC PUMPS

Modello	HP	kW	Q=Portata										Corr. Ass.		DNA	DNM
			l/min	0	40	60	80	100	120	160	200	240	[A]			
			m ³ /h	0	2,4	3,6	4,8	6	7,2	9,6	12	14,4	230V	400V		
	2x	2x	H=Prevalenza [m]										2x	2x		
2GP COMPACT A/8M	0,75	0,55	46	39,7	36,1	32	27,4	22,4	10,5	-	-	3,5	-	G1½	G1½	
2GP COMPACT A/10M	1,2	0,9	62	56,5	53	48,5	43,5	37,1	20	-	-	5,4	-	G1½	G1½	
2GP COMPACT A/12M	1,2	0,9	74	67,5	63,5	58,5	52,5	45	24	-	-	5,4	-	G1½	G1½	
2GP COMPACT A/15M	1,75	1,3	86	79	74,5	69	62,5	54	28	-	-	7,4	-	G1½	G1½	
2GP COMPACT B/12M	1,2	0,9	51	-	47,5	46	43,5	41,5	35,2	27,6	18	5,4	-	G2	G1½	
2GP COMPACT B/15M	1,75	1,3	63	-	58	56	54	51,5	44,5	34,5	22	7,4	-	G2	G1½	
2GP COMPACT A/8	0,8	0,6	46	39,7	36,1	32	27,4	22,4	10,5	-	-	-	1,4	G1½	G1½	
2GP COMPACT A/10	1	0,75	62	56,5	53	48,5	43,5	37,1	20	-	-	-	1,9	G1½	G1½	
2GP COMPACT A/12	1,1	0,88	74	67,5	63,5	58,5	52,5	45	24	-	-	-	2,5	G1½	G1½	
2GP COMPACT A/15	1,5	1,1	86	79	74,5	69	62,5	54	28	-	-	-	2,5	G1½	G1½	
2GP COMPACT B/12	1,1	0,88	51	-	47,5	46	43,5	41,5	35,2	27,6	18	-	2,5	G2	G1½	
2GP COMPACT B/15	1,5	1,1	63	-	58	56	54	51,5	44,5	34,5	22	-	2,5	G2	G1½	

SPECIFICATIONS

Pressure booster unit consisting of 2 multi-stage horizontal pumps with technopolymer impellers and a cast iron body, COMPACT range, installed on their own galvanised steel base (with omega profile) and controlled via an electronic panel with alternating exchange at every start-up. The pumps are joined together by means of an intake manifold and a delivery manifold, both in AISI 304 stainless steel.

The unit is completed with 4 brass shut-off valves (2 on the intake side and 2 on the delivery side), 2 brass check valves (on the intake side), 2 brass connectors for the air supply, 1 pressure transducer (4-20mA) and 1 analogue pressure gauge. The unit is factory tested and assembled prior to consignment.

SEE ALL THE OPTIONALS ON PAGE 47

2GP MATRIX

FIXED SPEED UNITS WITH TWO ELECTRIC PUMPS



Pressure booster sets consisting of 2 centrifugal multi-stage horizontal electric pumps in AISI 304 stainless steel, designed for connection to membrane or air cushion pressure tanks or to autoclave systems. Particularly suitable for domestic water supply, distribution networks related to the building service sector, water supply for industry in general, irrigation of gardens, parks and sports fields, and clean water movement in general.

The 2GP MATRIX units are available in 230V single-phase and 400V three-phase versions.

IDENTIFICATION CODE

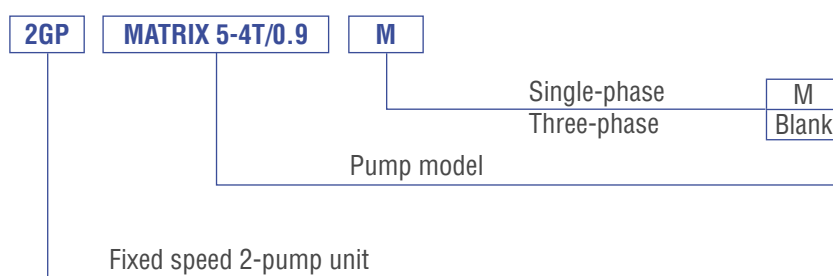

TECHNICAL DATA

Maximum working pressure	10 bar
Maximum liquid temperature	85°C
Electric motor in insulation class	F
Efficiency	IE2 for single phase IE3 for three phase
Protection degree	IP55
Supply voltage	230V ± 10% (single-phase versions) 400V ± 10% (three-phase versions)

2GP MATRIX

FIXED SPEED UNITS WITH TWO ELECTRIC PUMPS

Modello	HP	kW	Q=Portata														Corr. Ass.		DNA	DNM	
			l/min	0	40	60	90	120	160	200	260	320	400	500	700	900	[A]				
			m³/h	0	2,4	3,6	5,4	7,2	9,6	12	15,6	19,2	24	30	42	54	230V	400V			
2x	2x	H=Prevalenza [m]														2x	2x				
2GP MATRIX 3-4T/0,65M	1	0,75	45	42	39,1	34	27,2	16	-	-	-	-	-	-	-	-	-	4,4	-	G1½	G1½
2GP MATRIX 3-5T/0,75M	1	0,75	56,5	52,5	49	42,5	34	20	-	-	-	-	-	-	-	-	-	4,4	-	G1½	G1½
2GP MATRIX 3-6T/0,9M	1,2	0,9	68	62,5	58,5	51	41	24	-	-	-	-	-	-	-	-	-	5,4	-	G1½	G1½
2GP MATRIX 3-7T/1,3M	1,75	1,3	79	73	68,5	59,5	47,5	28	-	-	-	-	-	-	-	-	-	7,4	-	G1½	G1½
2GP MATRIX 3-8T/1,3M	1,75	1,3	90,5	83,5	78	68	54,5	32	-	-	-	-	-	-	-	-	-	7,4	-	G1½	G1½
2GP MATRIX 3-9T/1,5M	2	1,5	102	94	88	76,5	61	36	-	-	-	-	-	-	-	-	-	9	-	G1½	G1½
2GP MATRIX 5-4T/0,9M	1,2	0,9	46	-	43	41	38,6	34,7	29,4	17,6	-	-	-	-	-	-	-	5,4	-	G2	G1½
2GP MATRIX 5-5T/1,3M	1,75	1,3	57,5	-	54	51	48,5	43,5	36,7	22	-	-	-	-	-	-	-	7,4	-	G2	G1½
2GP MATRIX 5-6T/1,3M	1,75	1,3	69	-	64,5	61,5	58	52	44	26,4	-	-	-	-	-	-	-	7,4	-	G2	G1½
2GP MATRIX 5-7T/1,5M	2	1,5	80,5	-	75,5	72	67,5	61	51,5	30,8	-	-	-	-	-	-	-	9	-	G2	G1½
2GP MATRIX 5-8T/2,2M	3	2,2	92	-	86	82	77	69,5	58,5	35,2	-	-	-	-	-	-	-	12,3	-	G2	G1½
2GP MATRIX 5-9T/2,2M	3	2,2	104	-	97	92	87	78	66	39,6	-	-	-	-	-	-	-	12,3	-	G2	G1½
2GP MATRIX 10-3T/1,3M	1,75	1,3	36	-	-	-	33,3	32,1	30,9	28,6	25,5	19,3	8,7	-	-	-	-	7,4	-	G2½	G2½
2GP MATRIX 10-4T/1,5M	2	1,5	48	-	-	-	44,5	43	41	38,1	34	25,7	11,6	-	-	-	-	9	-	G2½	G2½
2GP MATRIX 10-5T/2,2M	3	2,2	60	-	-	-	55,5	53,5	51,5	47,5	42,5	32,1	14,5	-	-	-	-	12,3	-	G2½	G2½
2GP MATRIX 10-6T/2,2M	3	2,2	72	-	-	-	66,5	64,5	62	57	51	38,5	17,4	-	-	-	-	12,3	-	G2½	G2½
2GP MATRIX 18-3T/2,2M	3	2,2	36,3	-	-	-	-	-	-	33	31,9	30,4	28,1	21,3	7,8	-	-	12,3	-	G3	G3
2GP MATRIX 3-4T/0,65	0,9	0,65	45	42	39,1	34	27,2	16	-	-	-	-	-	-	-	-	-	1,7	-	G1½	G1½
2GP MATRIX 3-5T/0,75	1	0,75	56,5	52,5	49	42,5	34	20	-	-	-	-	-	-	-	-	-	1,7	-	G1½	G1½
2GP MATRIX 3-6T/0,9	1,2	0,9	68	62,5	58,5	51	41	24	-	-	-	-	-	-	-	-	-	2,5	-	G1½	G1½
2GP MATRIX 3-7T/1,3	1,8	1,3	79	73	68,5	59,5	47,5	28	-	-	-	-	-	-	-	-	-	3,3	-	G1½	G1½
2GP MATRIX 3-8T/1,3	1,8	1,3	90,5	83,5	78	68	54,5	32	-	-	-	-	-	-	-	-	-	3,3	-	G1½	G1½
2GP MATRIX 3-9T/1,5	2	1,5	102	94	88	76,5	61	36	-	-	-	-	-	-	-	-	-	3,8	-	G1½	G1½
2GP MATRIX 5-4T/0,9	1,2	0,9	46	-	43	41	38,6	34,7	29,4	17,6	-	-	-	-	-	-	-	2,5	-	G2	G1½
2GP MATRIX 5-5T/1,3	1,8	1,3	57,5	-	54	51	48,5	43,5	36,7	22	-	-	-	-	-	-	-	3,3	-	G2	G1½
2GP MATRIX 5-6T/1,3	1,8	1,3	69	-	64,5	61,5	58	52	44	26,4	-	-	-	-	-	-	-	3,3	-	G2	G1½
2GP MATRIX 5-7T/1,5	2	1,5	80,5	-	75,5	72	67,5	61	51,5	30,8	-	-	-	-	-	-	-	3,8	-	G2	G1½
2GP MATRIX 5-8T/2,2	3	2,2	92	-	86	82	77	69,5	58,5	35,2	-	-	-	-	-	-	-	4,7	-	G2	G1½
2GP MATRIX 5-9T/2,2	3	2,2	104	-	97	92	87	78	66	39,6	-	-	-	-	-	-	-	4,7	-	G2	G1½
2GP MATRIX 10-3T/1,3	1,8	1,3	36	-	-	-	33,3	32,1	30,9	28,6	25,5	19,3	8,7	-	-	-	-	3,3	-	G2½	G2½
2GP MATRIX 10-4T/1,5	2	1,5	48	-	-	-	44,5	43	41	38,1	34	25,7	11,6	-	-	-	-	3,8	-	G2½	G2½
2GP MATRIX 10-5T/2,2	3	2,2	60	-	-	-	55,5	53,5	51,5	47,5	42,5	32,1	14,5	-	-	-	-	4,7	-	G2½	G2½
2GP MATRIX 10-6T/2,2	3	2,2	72	-	-	-	66,5	64,5	62	57	51	38,5	17,4	-	-	-	-	4,7	-	G2½	G2½
2GP MATRIX 18-3T/2,2	3	2,2	36,3	-	-	-	-	-	-	33	31,9	30,4	28,1	21,3	7,8	-	-	4,7	-	G3	G3
2GP MATRIX 18-4T/3	4	3	48,5	-	-	-	-	-	-	44	42,5	40,5	37,4	28,4	10,4	-	-	6,4	-	G3	G3
2GP MATRIX 18-5T/4	5,5	4	60,5	-	-	-	-	-	-	55	53	50,5	47	35,5	13	-	-	8,7	-	G3	G3
2GP MATRIX 18-6T/4	5,5	4	72,5	-	-	-	-	-	-	66	64	60,5	56	42,5	15,6	-	-	8,7	-	G3	G3

SPECIFICATIONS

Pressure booster unit consisting of 2 centrifugal multi-stage horizontal pumps in AISI 304 stainless steel, MATRIX range, installed on their own galvanised steel base (with omega profile) and controlled via an electronic panel with alternating exchange at every start-up. The pumps are joined together by means of an intake manifold and a delivery manifold, both in AISI 304 stainless steel. The unit is completed with 4 brass shut-off valves (2 on the intake side and 2 on the delivery side), 2 brass check valves (on the intake side), 2 brass connectors for the air supply, 1 pressure transducer (4-20mA) and 1 analogue pressure gauge. The unit is factory tested and assembled prior to consignment.

SEE ALL THE OPTIONALS ON PAGE 47

2GP CVM

FIXED SPEED UNITS WITH TWO ELECTRIC PUMPS



Pressure booster sets consisting of 2 centrifugal multi-stage vertical electric pumps in cast iron, designed for connection to membrane or air cushion pressure tanks or to autoclave systems. Particularly suitable for domestic water supply, distribution networks related to the building service sector, water supply for industry in general, irrigation of gardens, parks and sports fields, and clean water movement in general.

The 2GP CVM units are available in 230V single-phase and 400V three-phase versions.

IDENTIFICATION CODE

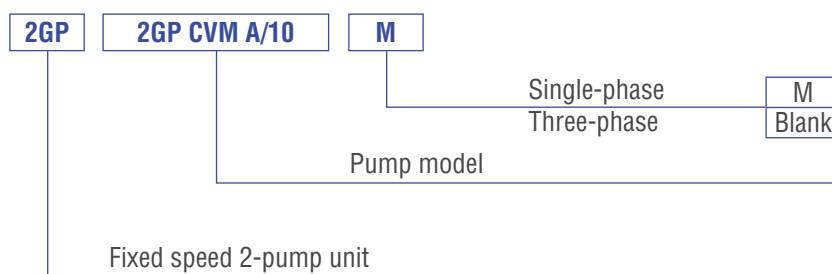

TECHNICAL DATA

Maximum working pressure	11 bar
Maximum liquid temperature	40°C
Electric motor in insulation class	F
Efficiency	IE2 for single phase IE3 for three phase
Protection degree	IP44
Supply voltage	230V ± 10% (single-phase versions) 400V ± 10% (three-phase versions)

2GP CVM

FIXED SPEED UNITS WITH TWO ELECTRIC PUMPS

Modello	HP	kW	Q=Portata										Corr. Ass.		DNA	DNM
			l/min	0	40	60	80	100	120	160	200	240	[A]			
			m ³ /h	0	2,4	3,6	4,8	6	7,2	9,6	12	14,4	230V	400V		
	2x	2x	H=Prevalenza [m]										2x	2x		
2GP CVM A/8M	0,75	0,55	47,5	42,5	39,4	35,6	31,1	25,9	12,8	-	-	3,5	-	G2	G2	
2GP CVM A/10M	1,2	0,9	62,5	57,5	54	49,5	43,5	36,6	19,5	-	-	5,4	-	G2	G2	
2GP CVM A/12M	1,2	0,9	75	69	65	59,5	52,5	44	23,4	-	-	5,4	-	G2	G2	
2GP CVM A/15M	1,75	1,3	87,5	80,5	75,5	69,5	61	51	27,3	-	-	7,4	-	G2	G2	
2GP CVM A/18M	1,75	1,3	103	94,5	88	80	70	58,5	28,8	-	-	7,4	-	G2	G2	
2GP CVM B/10M	1,2	0,9	38,1	-	36,2	35,1	33,7	32	27,5	21,6	14,7	5,4	-	G2	G2	
2GP CVM B/12M	1,2	0,9	51	-	48	46,8	45	42,6	36,6	28,8	19,6	5,4	-	G2	G2	
2GP CVM B/15M	1,75	1,3	63,5	-	60,5	58,5	56,2	53,3	45,8	36	24,5	7,4	-	G2	G2	
2GP CVM B/20M	2	1,5	78,5	-	74	72	69	65,5	56	44,5	30,6	9	-	G2	G2	
2GP CVM B/23M	2	1,5	91,5	-	86	84	80,5	76,5	65,5	51,5	35,7	9	-	G2	G2	
2GP CVM A/8	0,8	0,6	47,5	42,5	39,4	35,6	31,1	25,9	12,8	-	-	-	1,4	G2	G2	
2GP CVM A/10	1	0,75	62,5	57,5	54	49,5	43,5	36,6	19,5	-	-	-	1,7	G2	G2	
2GP CVM A/12	1,2	0,9	75	69	65	59,5	52,5	44	23,4	-	-	-	2,5	G2	G2	
2GP CVM A/15	1,5	1,1	87,5	80,5	75,5	69,5	61	51	27,3	-	-	-	2,5	G2	G2	
2GP CVM A/18	1,8	1,3	103	94,5	88	80	70	58,5	28,8	-	-	-	3,3	G2	G2	
2GP CVM B/10	1	0,75	38,1	-	36,2	35,1	33,7	32	27,5	21,6	14,7	-	1,7	G2	G2	
2GP CVM B/12	1,2	0,9	51	-	48	46,8	45	42,6	36,6	28,8	19,6	-	2,5	G2	G2	
2GP CVM B/15	1,5	1,1	63,5	-	60,5	58,5	56,2	53,3	45,8	36	24,5	-	2,5	G2	G2	
2GP CVM B/20	2	1,5	78,5	-	74	72	69	65,5	56	44,5	30,6	-	3,8	G2	G2	
2GP CVM B/23	2,3	1,7	91,5	-	86	84	80,5	76,5	65,5	51,5	35,7	-	4,1	G2	G2	
2GP CVM B/25	2,5	1,85	105	-	98,5	96	92	87	74,5	59	41	-	4,7	G2	G2	

SPECIFICATIONS

Pressure booster unit consisting of 2 multi-stage vertical pumps with technopolymer impellers and a cast iron body, CVM range, installed on their own galvanised steel base (with omega profile) and controlled via an electronic panel with alternating exchange at every start-up. The pumps are joined together by means of an intake manifold and a delivery manifold, both in AISI 304 stainless steel.

The unit is completed with 4 brass shut-off valves (2 on the intake side and 2 on the delivery side), 2 brass check valves (on the intake side), 2 brass connectors for the air supply, 1 pressure transducer (4-20mA) and 1 analogue pressure gauge. The unit is factory tested and assembled prior to consignment.

SEE ALL THE OPTIONALS ON PAGE 47

2GP EVMSG

FIXED SPEED UNITS WITH TWO ELECTRIC PUMPS



Pressure booster sets consisting of 2 centrifugal multi-stage vertical electric pumps in cast iron, designed for connection to membrane or air cushion pressure tanks or to autoclave systems. Particularly suitable for domestic water supply, distribution networks related to the building service sector, water supply for industry in general, irrigation of gardens, parks and sports fields, and clean water movement in general.

The 2GP EVMSG units are available in 230V single-phase and 400V three-phase versions.

IDENTIFICATION CODE

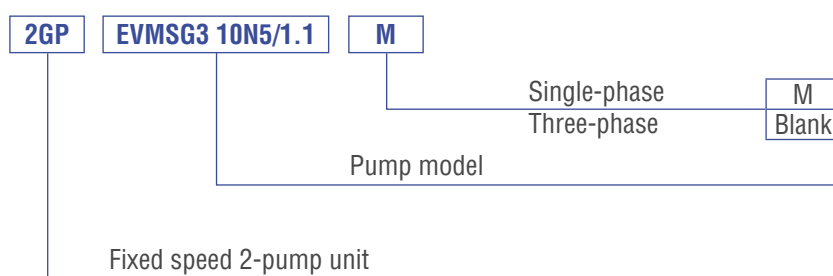

TECHNICAL DATA

Maximum working pressure	10 bar
Maximum liquid temperature	80°C
Electric motor in insulation class	F
Efficiency	IE2 for single phase IE3 for three phase
Protection degree	IP55
Supply voltage	230V ± 10% (single-phase versions) 400V ± 10% (three-phase versions)

2GP EVMSG

FIXED SPEED UNITS WITH TWO ELECTRIC PUMPS

2GP EVMSG 3-5

Modello	kW x2	HP x2	Q=Portata										Corr. Ass. [A]		DNA	DNM
			l/min	0	40	60	80	120	150	200	260	1~	3~			
			m³/h	0	2,4	3,6	4,8	7,2	9,6	12	15,6	230V	400V			
H=Prevalenza [m]																
2GP EVMSG3 7N5/0.75 (M)	0,75	1		51,5	49,5	47,5	45	38,3	29,2	-	-	5	1,7	G1½	G1½	
2GP EVMSG3 8N5/0.75 (M)	0,75	1		59	56,5	54,5	51,5	44	33,4	-	-	5	1,7	G1½	G1½	
2GP EVMSG3 9N5/1.1 (M)	1,1	1,5		66,5	63,5	61	58	49	37,6	-	-	6,8	2,5	G1½	G1½	
2GP EVMSG3 12N5/1.1 (M)	1,1	1,5		89	84,5	81,5	77,5	65,5	50	-	-	6,8	2,5	G1½	G1½	
2GP EVMSG5 5N5/1.1 (M)	1,1	1,5		47,5	-	-	45	42,5	39,9	34,5	25,5	6,8	2,5	G2	G2	
2GP EVMSG5 7N5/1.5 (M)	1,5	2		66,5	-	-	63	59,5	56	48,5	35,7	8,7	3,3	G2	G2	
2GP EVMSG5 10N5/2.2 (M)	2,2	3		95	-	-	90	88,5	80	69	51	12,3	4,7	G2½	G2½	

2GP EVMSG 10-15-20

Modello	kW x2	HP x2	Q=Portata														Corr. Ass. [A]		DNA	DNM
			l/min	0	150	200	260	300	360	400	500	600	700	800	900	960	1~	3~		
			m³/h	0	9	12	15,6	18	21,6	24	30	36	42	48	54	57,6	230V	400V		
H=Prevalenza [m]																				
2GP EVMSG10 6N5/2.2 (M)	2,2	3		65,5	63,5	62,5	59	56	50	45	29,5	-	-	-	-	12,3	4,7	G2½	G2½	
2GP EVMSG10 8N5/3.0	3,0	4		87	84,5	83,5	79	74,5	66,5	59,5	39,3	-	-	-	-	-	6,4	G2½	G2½	
2GP EVMSG10 9N5/4.0	4,0	5,5		98	95,5	93,5	89	84	74,5	67	44	-	-	-	-	-	8,7	G2½	G2½	
2GP EVMSG15 4N5/4.0	4,0	5,5		59	-	-	55	54,5	53	52	50	46,5	41	33,6	-	-	8,7	G3	G3	
2GP EVMSG15 6N5/5.5	5,5	7,5		88,5	-	-	82,5	81,5	79,5	78	74,5	69,5	61	50,5	-	-	10,4	G3	G3	
2GP EVMSG20 3N5/5.5	4,0	5,5		50,5	-	-	-	46	45	43,4	41,6	39,2	35,5	29,9	26,2	-	8,7	DN100	DN100	
2GP EVMSG20 4N5/5.5	5,5	7,5		67	-	-	-	60,8	59,8	57,8	55,4	52,3	47	39,8	34,9	-	10,4	DN100	DN100	
2GP EVMSG20 6N5/7.5	7,5	10		101	-	-	-	91	89,5	86,5	83	79	71	60	52	-	10,4	DN100	DN100	

2GP EVMSG 32-45

Modello	kW x2	HP x2	Q=Portata										Corr. Ass. [A]	DNA	DNM
			l/min	0	400	700	1000	1200	1400	1600	1800	2000			
			m³/h	0	24	42	60	72	84	96	108	120			
H=Prevalenza [m]															
2GP EVMSG32 3-0F5/5.5 ZN	5,5	7,5		63	59	52	43	36,4	28,2	-	-	-	6	DN125	DN100
2GP EVMSG32 4-0F5/7.5 ZN	7,5	10		83,5	79	70	58	49,5	38,7	-	-	-	13,6	DN125	DN100
2GP EVMSG45 2-0F5/7.5 ZN	7,5	10		54	-	49	46,5	44,5	41,5	38,1	33	28,7	13,6	DN150	DN125

SPECIFICATIONS

Pressure booster unit consisting of 2 multi-stage vertical pumps in AISI 304 stainless steel with body in cast iron, EVMSG range, installed on their own galvanised steel base (with omega profile) and controlled via an electronic panel with alternating exchange at every start-up. The pumps are joined together by means of an intake manifold in AISI 304 stainless steel (in galvanised steel for EVMSG 32-45) and a delivery manifold in AISI 304 stainless steel (in galvanised steel for EVMSG 32-45). The unit is completed with 4 brass shut-off valves (2 on the intake side and 2 on the delivery side), 2 brass check valves (on the intake side), 2 brass connectors for the air supply on threaded versions (for flanged versions, connection point kit for air supply connection available upon request as an optional), 1 pressure transducer (4-20mA) and 1 analogue pressure gauge. The unit is factory tested and assembled prior to consignment.

SEE ALL THE OPTIONALS ON PAGE 47

3GP EVMSG

FIXED SPEED UNITS WITH THREE ELECTRIC PUMPS



Pressure booster sets consisting of 3 multi-stage vertical electric pumps in cast iron, designed for connection to membrane or air cushion pressure tanks or to autoclave systems. Particularly suitable for domestic water supply, distribution networks related to the building service sector, water supply for industry in general, irrigation of gardens, parks and sports fields, and clean water movement in general.

The 3GP EVMSG units are available in the 400V three-phase version.

IDENTIFICATION CODE

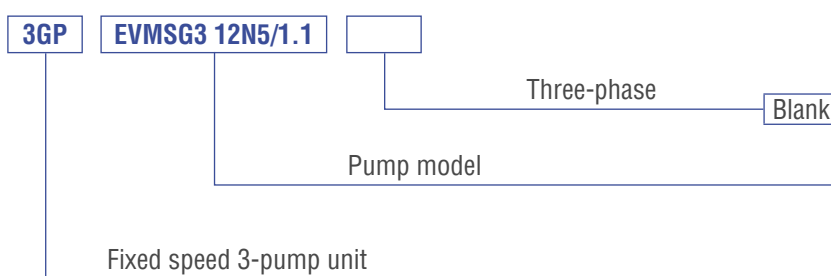

TECHNICAL DATA

Maximum working pressure	10 bar
Maximum liquid temperature	80°C
Electric motor in insulation class	F
Efficiency	IE2 for single phase IE3 for three phase
Protection degree	IP55
Supply voltage	400V ± 10% (three-phase versions)

3GP EVMSG

FIXED SPEED UNITS WITH THREE ELECTRIC PUMPS

3GP EVMSG 3-5-10

Modello	kW x3	HP x3	Q=Portata													Corr. Ass. [A] 400V	DNA	DNM
			l/min	0	60	90	120	180	225	300	390	450	540	600	750			
			m³/h	0	3,6	5,4	7,2	10,8	13,5	18	23,4	27	32,4	36	45			
H=Prevalenza [m]																		
3GP EVMSG3 8N5/0,75	0,75	1	59	56,5	54,5	52	44	33,4	-	-	-	-	-	-	1,7	G2	G2	
3GP EVMSG3 12N5/1,1	1,1	1,5	89	84,5	81,5	77,5	65,5	50	-	-	-	-	-	2,5	G2	G2		
3GP EVMSG5 5N5/1,1	1,1	1,5	47,5	-	-	45	42,5	39,9	34,5	25,5	-	-	-	2,5	G2½	G2½		
3GP EVMSG5 7N5/1,5	1,1	1,5	66,5	-	-	63	59,5	56	48,5	35,7	-	-	-	3,3	G2½	G2½		
3GP EVMSG5 8N5/2,2	2,2	3	76	-	-	72	68	64	55	41	-	-	-	4,7	G2½	G2½		
3GP EVMSG5 10N5/2,2	2,2	3	95	-	-	90	88,5	80	69	51	-	-	-	4,7	G2½	G2½		
3GP EVMSG10 6N5/2,2	2,2	3	65,5	-	-	-	-	63,5	62,5	59	56	50	45	29,5	4,7	G3	G3	
3GP EVMSG10 7N5/3	3	4	76,5	-	-	-	-	74	73	69	65,5	58	52	34,4	6,4	G3	G3	
3GP EVMSG10 8N5/3	3	4	87	-	-	-	-	84,5	83,5	79	74,5	66,5	59,5	39,3	6,4	G3	G3	
3GP EVMSG10 9N5/4	4	5,5	98	-	-	-	-	95,5	93,5	89	84	74,5	67	44	8,7	G3	G3	

3GP EVMSG 15-20

Modello	kW x3	HP x3	Q=Portata											Corr. Ass. [A] 400V	DNA	DNM	
			l/min	0	390	450	540	600	750	900	1050	1200	1350				1440
			m³/h	0	23,4	27	32,4	36	45	54	63	72	81				6,4
H=Prevalenza [m]																	
3GP EVMSG15 4N5/4	4	5,5	59	55	54,5	53	2	50	46,5	41	33,6	-	-	8,7	DN100	DN100	
3GP EVMSG15 5N5/5,5	5,5	7,5	73,5	69	68	66	65	62	58	51	42	-	-	10,4	DN100	DN100	
3GP EVMSG15 6N5/5,5	5,5	7,5	88,5	82,5	81,5	79,5	78	74,5	69,5	61	50,5	-	-	10,4	DN100	DN100	
3GP EVMSG20 3N5/4	3	4	50,5	-	-	46	45	43,4	41,6	39,2	35,5	29,9	26,2	8,7	DN100	DN100	
3GP EVMSG20 4N5/5,5	5,5	7,5	67	-	-	60,8	59,8	57,8	55,4	52,3	47	39,8	34,9	10,4	DN100	DN100	
3GP EVMSG20 6N5/7,5	7,5	10	101	-	-	91	89,5	86,5	83	79	71	60	52	13,6	DN100	DN100	

3GP EVMSG 32-45

Modello	kW x3	HP x3	Q=Portata								Corr. Ass. [A] 400V	DNA	DNM			
			l/min	0	600	1050	1500	1800	2100	2400				2700	3000	
			m³/h	0	36	63	90	108	126	144				162	180	
H=Prevalenza [m]																
3GP EVMSG32 3-0F5/5,5 ZN	5,5	7,5	63	59	52	43	36,4	28,2	-	-	-	-	-	10,4	DN150	DN125
3GP EVMSG32 4-0F5/7,5 ZN	7,5	10	83,5	79	70	58	49,5	38,7	-	-	-	-	-	13,6	DN150	DN125
3GP EVMSG45 2-0F5/7,5 ZN	7,5	10	54	-	49	46,5	44,5	41,5	38,1	33	28,7	-	-	13,6	DN200	DN150

SPECIFICATIONS

Pressure booster unit consisting of 3 multi-stage vertical pumps in AISI 304 stainless steel with body in cast iron, EVMSG range, installed on their own galvanised steel base (with omega profile) and controlled via an electronic panel with alternating exchange at every start-up. The pumps are joined together by means of an intake manifold in AISI 304 stainless steel (in galvanised steel for EVMSG 32-45) and a delivery manifold in AISI 304 stainless steel (in galvanised steel for EVMSG 32-45). The unit is completed with 6 brass shut-off valves (3 on the intake side and 3 on the delivery side), 3 brass check valves (on the intake side), 3 brass connectors for the air supply on threaded versions (for flanged versions, connection point kit for air supply connection available upon request as an optional), 1 pressure transducer (4-20mA) and 1 analogue pressure gauge. The unit is factory tested and assembled prior to consignment.

SEE ALL THE OPTIONALS ON PAGE 47

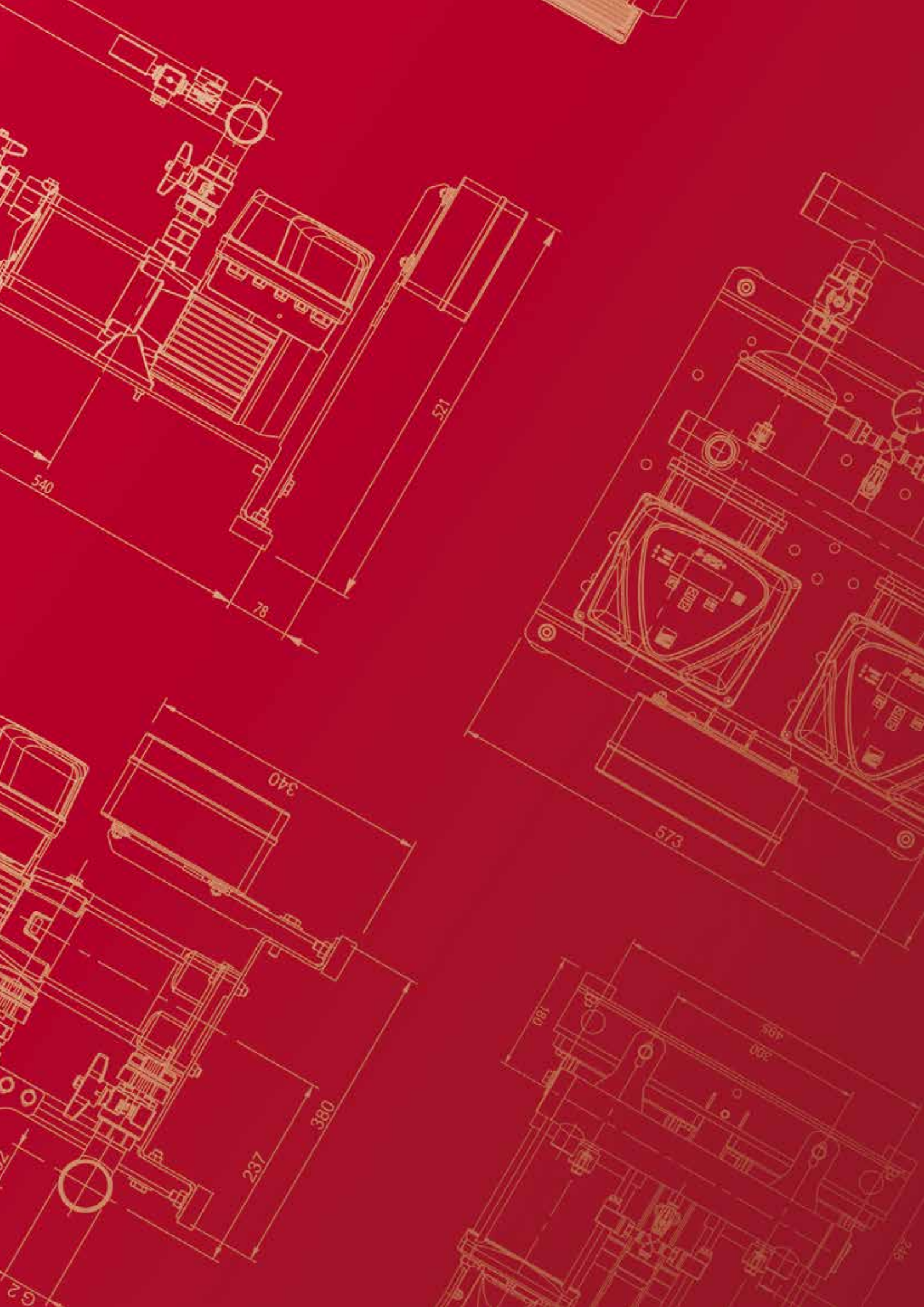

540

521

78

340

573

237

380

180

390

485

246

G 2

Variable speed units



1GPE JEX

VARIABLE SPEED UNITS WITH AN ELECTRIC PUMP



Pressure booster system with a self-priming stainless steel electric pump with constant pressure control, including a variable speed electronic inverter device (model E-SPD+) and 2-litre expansion tank. The 1GPE systems are particularly suitable for domestic pressure boosting, limited garden irrigation, washing vehicles and clean water movement in general. The new E-SPD+ inverter device boasts easy use and programming thanks to simplified, intuitive software that allows the user to make the settings and start-up in about 2 minutes.

The 1GPE systems are available in 230V single-phase and 400V three-phase versions but, in both cases, the pump installed is of the three-phase type to ensure greater efficiency and lower energy consumption.

IDENTIFICATION CODE

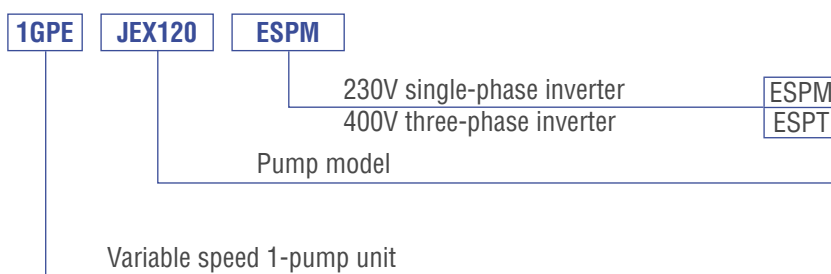

TECHNICAL DATA

Maximum working pressure	6 bar
Maximum liquid temperature	45°C
Electric motor in insulation class	F
Efficiency	IE3
Protection degree	IP54
Supply voltage	230V ± 10% (single-phase versions) 400V ± 10% (three-phase versions)

1GPE JEX

VARIABLE SPEED UNITS WITH AN ELECTRIC PUMP

1GPE JEX

Model	kW	HP	Q=Flow rate								Input curr.		DNA	DNM
			l/min	0	20	40	50	60	70	75	[A]	3~		
			m ³ /h	0	1.2	2.4	3	3.6	4.2	4.5	230V			
			H=Head [m]											
1GPE JEX120 ESP(M)(T)	0.88	1.2		50.0	41.0	34.0	30.5	27.5	24.5	-	3	1.7	G1¼	G1
1GPE JEX150 ESP(M)(T)	1.1	1.5		59.0	49.0	40.5	37.0	34.0	31.0	29.5	5.8	3.3	G1¼	G1

SPECIFICATIONS

Pressure booster set with constant pressure control with variable frequency, consisting of a self-priming electric pump in AISI 304 stainless steel with a technopolymer impeller (JEX range) including the E-SPD+ inverter device and 1 five-way connector in AISI 304 stainless steel (on the intake side), 1 analogue pressure gauge and 1 pressure transducer (4-20mA). The 1GPE pressure booster set comes fitted as standard with a 2-litre expansion tank.

The pressure booster sets are designed to be connected and to communicate with other identical units, working in parallel.

SEE ALL THE OPTIONALS ON PAGE 47

1GPE MATRIX

VARIABLE SPEED UNITS WITH AN ELECTRIC PUMP



Pressure booster system with a multi-stage stainless steel electric pump with constant pressure control, including a variable speed electronic inverter device (model E-SPD+) and 2-litre expansion tank. The 1GPE systems are particularly suitable for domestic pressure boosting, limited garden irrigation, washing vehicles and clean water movement in general. The new E-SPD+ inverter device boasts easy use and programming thanks to simplified, intuitive software that allows the user to make the settings and start-up in about 2 minutes.

The 1GPE systems are available in 230V single-phase and 400V three-phase versions but, in both cases, the pump installed is of the three-phase type to ensure greater efficiency and lower energy consumption.

IDENTIFICATION CODE

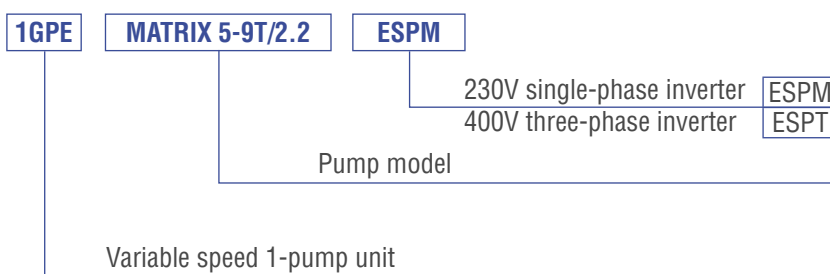

TECHNICAL DATA

Maximum working pressure	10 bar
Maximum liquid temperature	80°C
Electric motor in insulation class	F
Efficiency	IE3
Protection degree	IP55
Supply voltage	230V ± 10% (single-phase versions) 400V ± 10% (three-phase versions)

1GPE MATRIX

VARIABLE SPEED UNITS WITH AN ELECTRIC PUMP

1GPE MATRIX

Model	kW	HP	Q=Flow rate														Input curr.		DNA	DNM
			l/min	0	20	30	45	60	80	100	130	160	200	250	350	450	[A]	3~		
			m ³ /h	0	1.2	1.8	2.7	3.6	4.8	6	7.8	9.6	12	15	21	27	230V			
H=Head [m]																				
1GPE MATRIX 3-5T/0.75 ESPM	0.75	1	56.5	52.5	49	42.5	34	20	-	-	-	-	-	-	-	-	3	-	G1"	G1"
1GPE MATRIX 3-6T/0.9 ESPM	0.9	1.2	68	62.5	58.5	51	41	24	-	-	-	-	-	-	-	-	4.3	-	G1"	G1"
1GPE MATRIX 5-5T/1.3 ESPM	1.3	1.8	57.5	-	54	51	48.5	43.5	36.7	22	-	-	-	-	-	-	5.8	-	G1¼"	G1"
1GPE MATRIX 5-6T/1.3 ESP(M)(T)	1.3	1.8	69	-	64.5	61.5	58	52	44	26.4	-	-	-	-	-	-	5.8	3.3	G1¼"	G1"
1GPE MATRIX 5-7T/1.5 ESP(M)(T)	1.5	2	80.5	-	75.5	72	67.5	61	51.5	30.8	-	-	-	-	-	-	6.6	3.8	G1¼"	G1"
1GPE MATRIX 5-9T/2.2 ESPM	2.2	3	104	-	97	92	87	78	66	39.6	-	-	-	-	-	-	8.2	-	G1¼"	G1"
1GPE MATRIX 10-4T/1.5 ESP(M)(T)	1.5	2	48	-	-	-	44.5	43	41	38.1	34	25.7	11.6	-	-	-	6.6	3.8	G1½"	G1¼"
1GPE MATRIX 10-5T/2.2 ESP(M)(T)	2.2	3	60	-	-	-	55.5	53.5	51.5	47.5	42.5	32.1	14.5	-	-	-	8.2	4.7	G1½"	G1¼"
1GPE MATRIX 10-6T/2.2 ESP(M)(T)	2.2	3	72	-	-	-	66.5	64.5	62	57	51	38.5	17.4	-	-	-	8.2	4.7	G1½"	G1¼"
1GPE MATRIX 18-6T/4 ESPT	4	5.5	72.5	-	-	-	-	-	-	66	64	60.5	56	42.5	15.6	-	8.7	-	G2"	G1½"

SPECIFICATIONS

Pressure booster set with constant pressure control with variable frequency, consisting of a multi-stage electric pump in AISI 304 stainless steel (MATRIX range) including the E-SPD+ inverter device and 1 five-way connector in AISI 304 stainless steel (on the delivery side), 1 analogue pressure gauge and 1 pressure transducer (4-20mA). The 1GPE pressure booster set comes fitted as standard with a 2-litre expansion tank.

The pressure booster sets are designed to be connected and to communicate with other identical units, working in parallel.

SEE ALL THE OPTIONALS ON PAGE 47

2GPE COMPACT

VARIABLE SPEED UNITS WITH TWO ELECTRIC PUMPS



Pressure booster sets consisting of 2 multi-stage horizontal electric pumps with a technopolymer impeller, including E-SPD+ inverter devices for constant pressure control. Particularly suitable for domestic and residential water supply, distribution networks related to the building service sector, water supply for industry in general, irrigation of gardens, parks and sports fields, and clean water movement in general.

The 2GPE COMPACT units are available in a 230V single-phase version, but the pump installed is of the three-phase type to ensure greater efficiency and lower energy consumption.

IDENTIFICATION CODE

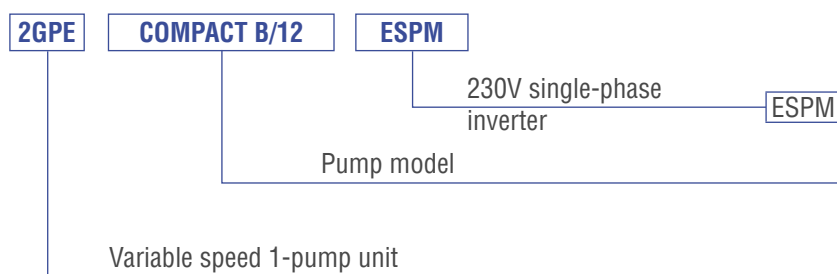

TECHNICAL DATA

Maximum working pressure	10 bar
Maximum liquid temperature	40°C
Electric motor in insulation class	F
Efficiency	IE3
Protection degree	IP44
Supply voltage	230V ± 10% (single-phase versions)

2GPE COMPACT

VARIABLE SPEED UNITS WITH TWO ELECTRIC PUMPS

2GPE COMPACT

Model	kW x2	HP x2	Q=Flow rate											Input curr. [A] 3~ 230V	DNA	DNM
			l/min m ³ /h	0	40	60	80	100	120	160	200	240				
				0	2.4	3.6	4.8	6	7.2	9.6	12	14.4				
			H=Head [m]													
2GPE COMPACT A/10 ESPM	0.75	1		62.0	56.5	53.0	48.5	43.5	37.1	20.0	-	-	3.3	G1½	G1½	
2GPE COMPACT A/12 ESPM	0.9	1.2		74.0	67.5	63.5	58.5	52.5	45.0	24.0	-	-	4.3	G1½	G1½	
2GPE COMPACT A/15 ESPM	1.1	1.5		86.0	79.0	74.5	69.0	62.5	54.0	28.0	-	-	4.3	G1½	G1½	
2GPE COMPACT B/12 ESPM	0.9	1.2		51.0	-	47.5	46.0	43.5	41.5	35.2	27.6	18.0	4.3	G2	G1½	
2GPE COMPACT B/15 ESPM	1.1	1.5		63.0	-	58.0	56.0	54.0	51.5	44.5	34.5	22.0	4.3	G2	G1½	

SPECIFICATIONS

Pressure booster sets with constant pressure control with variable frequency, consisting of 2 multi-stage horizontal electric pumps with technopolymer impellers and a cast iron body (COMPACT range), including E-SPD+ inverter devices mounted on the motor. The units are installed on their own galvanised steel base (with omega profile). The protection panel, with 2 suitably sized residual current switch disconnectors, has clean contacts directly connected to the E-SPD+ device for the main connections to the digital inputs and outputs available, without the need to intervene on the inverter devices themselves. The pumps are joined together by means of an intake manifold and a delivery manifold, both in AISI 304 stainless steel. The unit is completed with 4 brass shut-off valves (2 on the intake side and 2 on the delivery side), 2 brass check valves (on the delivery side), 2 pressure transducers (4-20mA) and 1 analogue pressure gauge. The unit is factory tested and assembled prior to consignment.

SEE ALL THE OPTIONALS ON PAGE 47

2GPE MATRIX

VARIABLE SPEED UNITS WITH TWO ELECTRIC PUMPS

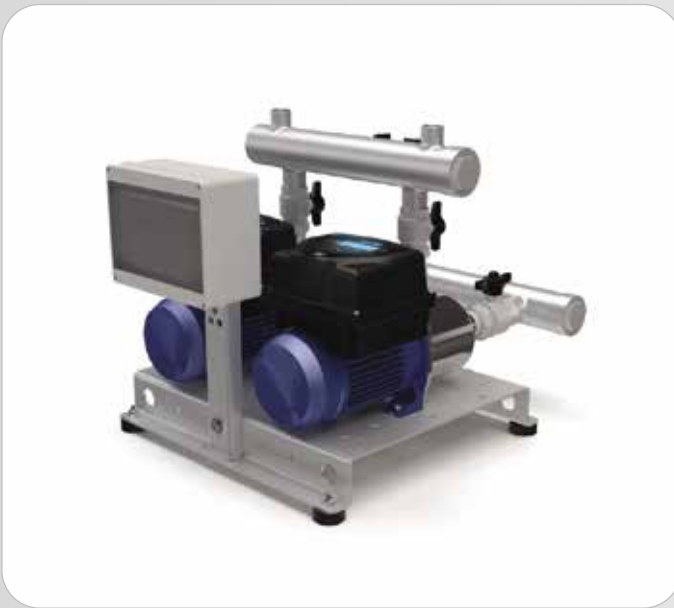

Pressure booster sets consisting of 2 multi-stage horizontal electric pumps in AISI 304 stainless steel, including E-SPD+ inverter devices for constant pressure control. Particularly suitable for domestic and residential water supply, distribution networks related to the building service sector, water supply for industry in general, irrigation of gardens, parks and sports fields, and clean water movement in general.

The 2GPE MATRIX units are available in 230V single-phase and 400V three-phase versions but, in both cases, the pump installed is of the three-phase type to ensure greater efficiency and lower energy consumption.

IDENTIFICATION CODE

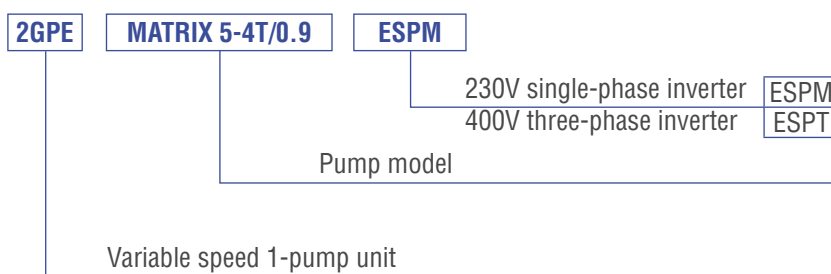

TECHNICAL DATA

Maximum working pressure	10 bar
Maximum liquid temperature	85°C
Electric motor in insulation class	F
Efficiency	IE3
Protection degree	IP55
Supply voltage	230V ± 10% (single-phase versions) 400V ± 10% (three-phase versions)

2GPE MATRIX

VARIABLE SPEED UNITS WITH TWO ELECTRIC PUMPS

2GPE MATRIX

Model	kW x2	HP x2	Q=Flow rate												Input curr. [A] 3~		DNA	DNM
			l/min	0	40	60	90	120	160	200	260	320	400	500	230V	400V		
			m ³ /h	0	2.4	3.6	5.4	7.2	9.6	12.0	15.6	19.2	24.0	30.0				
			H=Head [m]															
2GPE MATRIX 3-3T/0.65 ESPM	0.65	0.9	33.9	31.4	29.3	25.5	20.4	12	-	-	-	-	-	2.8	-	G1½	G1½	
2GPE MATRIX 3-4T/0.65 ESP(M)(T)	0.65	0.9	45	42	39.1	34	27.2	16	-	-	-	-	-	3.1	1.8	G1½	G1½	
2GPE MATRIX 3-5T/0.75 ESP(M)(T)	0.75	1	56.5	52.5	49	42.5	34	20	-	-	-	-	-	3	1.7	G1½	G1½	
2GPE MATRIX 3-6T/0.9 ESP(M)(T)	0.9	1.2	68	62.5	58.5	51	41	24	-	-	-	-	-	4.3	2.5	G1½	G1½	
2GPE MATRIX 3-7T/1.3 ESP(M)(T)	1.3	1.8	79	73	68.5	59.5	47.5	28	-	-	-	-	-	5.8	3.3	G1½	G1½	
2GPE MATRIX 3-8T/1.3 ESPT	1.3	1.8	90.5	83.5	78	68	54.5	32	-	-	-	-	-	-	3.3	G1½	G1½	
2GPE MATRIX 3-9T/1.5 ESPT	1.5	2	102	94	88	76.5	61	36	-	-	-	-	-	-	3.8	G1½	G1½	
2GPE MATRIX 5-3T/0.65 ESPM	0.65	0.9	34.5	-	32.3	30.7	29	26	22	13.2	-	-	-	3.1	-	G2	G1½	
2GPE MATRIX 5-4T/0.9 ESP(M)(T)	0.9	1.2	46	-	43	41	38.6	34.7	29.4	17.6	-	-	-	4.3	2.5	G2	G1½	
2GPE MATRIX 5-5T/1.3 ESP(M)(T)	1.3	1.8	57.5	-	54	51	48.5	43.5	36.7	22	-	-	-	5.8	3.3	G2	G1½	
2GPE MATRIX 5-6T/1.3 ESP(M)(T)	1.3	1.8	69	-	64.5	61.5	58	52	44	26.4	-	-	-	5.8	3.3	G2	G1½	
2GPE MATRIX 5-7T/1.5 ESPT	1.5	2	80.5	-	75.5	72	67.5	61	51.5	30.8	-	-	-	-	3.8	G2	G1½	
2GPE MATRIX 5-8T/2.2 ESPT	2.2	3	92	-	86	82	77	69.5	58.5	35.2	-	-	-	-	4.7	G2	G1½	
2GPE MATRIX 5-9T/2.2 ESPT	2.2	3	104	-	97	92	87	78	66	39.6	-	-	-	-	4.7	G2	G1½	
2GPE MATRIX 10-4T/1.5 ESPT	1.5	2.0	48	-	-	-	44.5	43	41	38.1	34	25.7	11.6	-	3.8	G2½	G2½	
2GPE MATRIX 10-5T/2.2 ESPT	2.2	3.0	60	-	-	-	55.5	53.5	51.5	47.5	42.5	32.1	14.5	-	4.7	G2½	G2½	
2GPE MATRIX 10-6T/2.2 ESPT	2.2	3.0	72	-	-	-	66.5	64.5	62	57	51	38.5	17.4	-	4.7	G2½	G2½	

SPECIFICATIONS

Pressure booster sets with constant pressure control with variable frequency, consisting of 2 multi-stage horizontal electric pumps in AISI 304 stainless steel (MATRIX range), including E-SPD+ inverter devices mounted on the motor. The units are installed on their own galvanised steel base (with omega profile).

The protection panel, with 2 suitably sized residual current switch disconnectors, has clean contacts directly connected to the E-SPD+ device for the main connections to the digital inputs and outputs available, without the need to intervene on the inverter devices themselves. The pumps are joined together by means of an intake manifold and a delivery manifold, both in AISI 304 stainless steel. The unit is completed with 4 brass shut-off valves (2 on the intake side and 2 on the delivery side), 2 brass check valves (on the delivery side), 2 pressure transducers (4-20mA) and 1 analogue pressure gauge. The unit is factory tested and assembled prior to consignment.

SEE ALL THE OPTIONALS ON PAGE 47

2GPE CVM

VARIABLE SPEED UNITS WITH TWO ELECTRIC PUMPS



Pressure booster sets consisting of 2 multi-stage vertical electric pumps in cast iron, including E-SPD+ inverter devices for constant pressure control. Particularly suitable for domestic and residential water supply, distribution networks related to the building service sector, water supply for industry in general, irrigation of gardens, parks and sports fields, and clean water movement in general.

The 2GPE CVM units are available in 230V single-phase and 400V three-phase versions but, in both cases, the pump installed is of the three-phase type to ensure greater efficiency and lower energy consumption.

IDENTIFICATION CODE

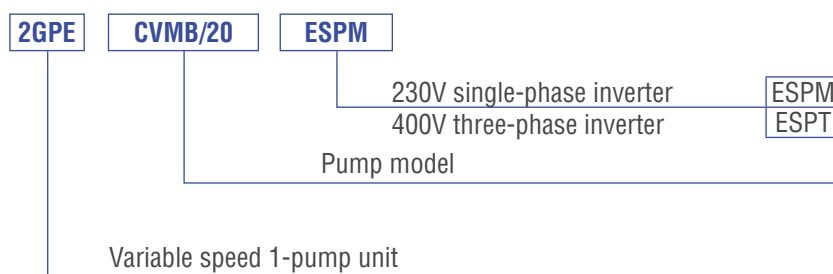

TECHNICAL DATA

Maximum working pressure	11 bar
Maximum liquid temperature	40°C
Electric motor in insulation class	F
Efficiency	IE3
Protection degree	IP44
Supply voltage	230V ± 10% (single-phase versions) 400V ± 10% (three-phase versions)

2GPE CVM

VARIABLE SPEED UNITS WITH TWO ELECTRIC PUMPS

2GPE CVM

Model	kW x2	HP x2	Q=Flow rate										Input curr. [A] 3~		DNA	DNM
			l/min	0	40	60	80	100	120	160	200	240	230V	400V		
			m ³ /h	0	2.4	3.6	4.8	6.0	7.2	9.6	12.0	14.4				
			H=Head [m]													
2GPE CVM A/10 ESP(M)(T)	0.75	1		62.5	57.5	54.0	49.5	43.5	36.6	19.5	-	-	3	1.7	G2	G2
2GPE CVM A/12 ESP(M)(T)	0.9	1.2		75.0	69.0	65.0	59.5	52.5	44.0	23.4	-	-	4.3	2.5	G2	G2
2GPE CVM A/15 ESP(M)(T)	1.1	1.5		87.5	80.5	75.5	69.5	61.0	51.0	27.3	-	-	4.3	2.5	G2	G2
2GPE CVM B/12 ESPM	0.9	1.2		51.0	-	48.0	46.8	45.0	42.6	36.6	28.8	19.6	4.3	-	G2	G2
2GPE CVM B/15 ESP(M)(T)	1.1	1.5		63.5	-	60.5	58.5	56.2	53.3	45.8	36.0	24.5	4.3	2.5	G2	G2
2GPE CVM B/20 ESP(M)(T)	1.5	2		78.5	-	74.0	72.0	69.0	65.5	56.0	44.5	30.6	6.6	3.8	G2	G2
2GPE CVM B/23 ESPT	1.7	2.3		91.5	-	86.0	84.0	80.5	76.5	65.5	51.5	35.7	-	4.1	G2	G2

SPECIFICATIONS

Pressure booster sets with constant pressure control with variable frequency, consisting of 2 multi-stage vertical electric pumps with technopolymer impellers and a cast iron body (CVM range), including E-SPD+ inverter devices mounted on the motor. The units are installed on their own galvanised steel base (with omega profile). The protection panel, with 2 suitably sized residual current switch disconnectors, has clean contacts directly connected to the E-SPD+ device for the main connections to the digital inputs and outputs available, without the need to intervene on the inverter devices themselves. The pumps are joined together by means of an intake manifold and a delivery manifold, both in AISI 304 stainless steel. The unit is completed with 4 brass shut-off valves (2 on the intake side and 2 on the delivery side), 2 brass check valves (on the delivery side), 2 pressure transducers (4-20mA) and 1 analogue pressure gauge. The unit is factory tested and assembled prior to consignment.

SEE ALL THE OPTIONALS ON PAGE 47

2GPE EVMSG

VARIABLE SPEED UNITS WITH TWO ELECTRIC PUMPS



Pressure booster sets consisting of 2 multi-stage vertical electric pumps in cast iron, including E-SPD+ inverter devices for constant pressure control. Particularly suitable for domestic and residential water supply, distribution networks related to the building service sector, water supply for industry in general, irrigation of gardens, parks and sports fields, and clean water movement in general.

The 2GPE EVMSG units are available in 230V single-phase and 400V three-phase versions but, in both cases, the pump installed is of the three-phase type to ensure greater efficiency and lower energy consumption.

IDENTIFICATION CODE

2GPE	EVMS(.)3 10N5/1.1	ESPM
		230V single-phase inverter ESPM 400V three-phase inverter ESPT
		Pump model
Variable speed 1-pump unit		

TECHNICAL DATA

Maximum working pressure	10 bar
Maximum liquid temperature	80°C
Electric motor in insulation class	F
Efficiency	IE3
Protection degree	IP55
Supply voltage	230V ± 10% (single-phase versions) 400V ± 10% (three-phase versions)

2GPE EVMSG

VARIABLE SPEED UNITS WITH TWO ELECTRIC PUMPS

2GPE EVMSG 3-5

Model	kW x2	HP x2	Q=Flow rate										Input curr. [A] 3~		DNA	DNM
			l/min	0	40	60	80	120	150	200	260	230V	400V			
			m³/h	0	2.4	3.6	4.8	7.2	9	12.0	15.6					
			H=Head [m]													
2GPE EVMSG3 8N5/0.75 ESP(M)(T)	0.75	1		59	56.5	54.5	51.5	44	33.4	-	-	3	1.7	G1½	G1½	
2GPE EVMSG3 9N5/1.1 ESPM	1.1	1.5		66.5	63.5	61	58	49	37.6	-	-	4.3	-	G1½	G1½	
2GPE EVMSG3 10N5/1.1 ESP(M)(T)	1.1	1.5		73.5	70.5	68	64.5	54.5	41.5	-	-	4.3	-	G1½	G1½	
2GPE EVMSG3 12N5/1.1 ESP(M)(T)	1.1	1.5		89	84.5	81.5	77.5	65.5	50.0	-	-	4.3	2.5	G1½	G1½	
2GPE EVMSG5 5N5/1.1 ESP(M)(T)	1.1	1.5		47.5	-	-	45	42.5	39.9	34.5	25.5	4.3	2.5	G2	G2	
2GPE EVMSG5 7N5/1.5 ESP(M)(T)	1.5	2		66.5	-	-	63	59.5	56	48.5	35.7	5.8	3.3	G2	G2	
2GPE EVMSG5 8N5/2.2 ESPT	2.2	3		76	-	-	72	68	64	55	41	-	4.7	G2	G2	
2GPE EVMSG5 9N5/2.2 ESPT	2.2	3		85.5	-	-	81	77	72	62	46	-	4.7	G2	G2	
2GPE EVMSG5 10N5/2.2 ESP(M)(T)	2.2	3		95.0	-	-	90	88.5	80	69	51	8.2	4.7	G2	G2	

2GPE EVMSG 10-15-20

Model	kW x2	HP x2	Q=Flow rate														Input curr. [A] 3~		DNA	DNM
			l/min	0	150	200	260	300	360	400	500	600	700	800	900	960	230V	400V		
			m³/h	0	9.0	12.0	15.6	18.0	21.6	24.0	30.0	36.0	42.0	48.0	54.0	57.6				
			H=Head [m]																	
2GPE EVMSG10 6N5/2.2 ESP(M)(T)	2.2	3		65.5	63.5	62.5	59	56	50	45	29.5	-	-	-	-	-	8.2	4.7	G2½	G2½
2GPE EVMSG10 7N5/3.0 ESPT	3	4		76.5	74	73	69	65.5	58	52	34.4	-	-	-	-	-	-	6.4	G2½	G2½
2GPE EVMSG10 8N5/3.0 ESPT	3	4		87.0	84.5	83.5	79	74.5	66.5	59.5	39.3	-	-	-	-	-	-	6.4	G2½	G2½
2GPE EVMSG10 9N5/4.0 ESPT	4	5.5		98	95.5	93.5	89.0	84.0	74.5	67.0	44.0	-	-	-	-	-	-	8.7	G2½	G2½
2GPE EVMSG15 4N5/4.0 ESPT	4	5.5		59	-	-	55	54.5	53	52	50	46.5	41	33.6	-	-	-	8.7	G3	G3
2GPE EVMSG15 6N5/5.5 ESPT	5.5	7.5		88.5	-	-	82.5	81.5	79.5	78	74.5	69.5	61	50.5	-	-	-	10.4	G3	G3
2GPE EVMSG20 3N5/4.0 ESPT	4	5.5		50.5	-	-	-	46	45	43.4	41.6	39.2	35.5	29.9	26.2	-	-	8.7	DN100	DN100
2GPE EVMSG20 4N5/5.5 ESPT	5.5	7.5		67	-	-	-	60.8	59.8	57.8	55.4	52.3	47	39.8	34.9	-	-	10.4	DN100	DN100
2GPE EVMSG20 6N5/7.5 ESPT	7.5	10		101	-	-	-	91	89.5	86.5	83	79	71	60	52	-	-	13.6	DN100	DN100

2GPE EVMSG 32-45

Model	kW x2	HP x2	Q=Flow rate										Input curr. [A] 3~ 400V		DNA	DNM			
			l/min	0	400	700	1000	1200	1400	1600	1800	2000	230V	400V					
			m³/h	0	24	42	60	72	84	96	108	120							
			H=Head [m]																
2GPE EVMSG32 3-0F5/5.5 ESPT ZN	5.5	7.5		63	59	52	43	36.4	28.2	-	-	-	-	-	-	12	-	DN125	DN100
2GPE EVMSG32 4-0F5/7.5 ESPT ZN	7.5	10		83.5	79	70	58.0	49.5	38.7	-	-	-	-	-	-	27.2	-	DN125	DN100
2GPE EVMSG45 2-0F5/7.5 ESPT ZN	7.5	10		54	-	49	46.5	44.5	41.5	38.1	33.0	28.7	-	-	-	27.2	-	DN150	DN125

SPECIFICATIONS

Pressure booster sets with constant pressure control with variable frequency, consisting of 2 multi-stage vertical electric pumps in AISI 304 stainless steel and a cast iron body (EVMSG range), including E-SPD+ inverter devices mounted on the motor. The units are installed on their own galvanised steel base. The protection panel, with 2 suitably sized residual current switch disconnectors, has clean contacts directly connected to the E-SPD+ device for the main connections to the digital inputs and outputs available, without the need to intervene on the inverter devices themselves. The pumps are joined together by means of an intake manifold in AISI 304 stainless steel (in galvanised steel for EVMSG 32-45) and a delivery manifold in AISI 304 stainless steel (in galvanised steel for EVMSG 32-45). The unit is completed with 4 shut-off valves (2 on the intake side and 2 on the delivery side), 2 check valves (on the delivery side), 2 pressure transducers (4-20mA) and 1 analogue pressure gauge. The unit is factory tested and assembled prior to consignment.

SEE ALL THE OPTIONALS ON PAGE 47

3GPE EVMSG

VARIABLE SPEED UNITS WITH THREE ELECTRIC PUMPS



Pressure booster sets consisting of 3 multi-stage vertical electric pumps in cast iron, including E-SPD+ inverter devices for constant pressure control. Particularly suitable for domestic and residential water supply, distribution networks related to the building service sector, water supply for industry in general, irrigation of gardens, parks and sports fields, and clean water movement in general.

The 3GPE EVMSG units are available in a 400V three-phase version, and the pump installed is of the three-phase type to ensure greater efficiency and lower energy consumption.

IDENTIFICATION CODE

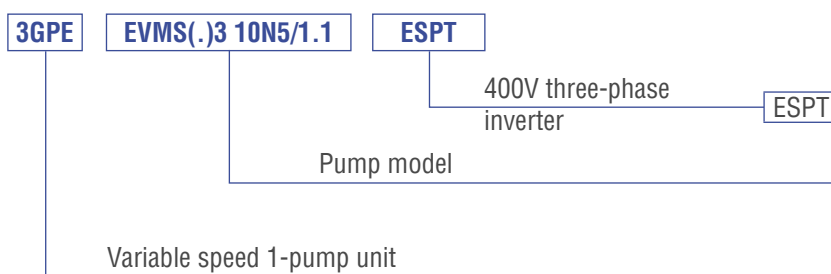

TECHNICAL DATA

Maximum working pressure	10 bar
Maximum liquid temperature	80°C
Electric motor in insulation class	F
Efficiency	IE3
Protection degree	IP55
Supply voltage	400V ± 10% (three-phase versions)

3GPE EVMSG

VARIABLE SPEED UNITS WITH THREE ELECTRIC PUMPS

3GPE EVMSG 3-5-10

Model	kW x3	HP x3	Q=Flow rate												Input curr. [A] 400V	DNA	DNM	
			l/min	0	60	90	120	180	225	300	390	450	540	600				750
			m ³ /h	0	3.6	5.4	7.2	10.8	13.5	18	23.4	27	32.4	36				45
H=Head [m]																		
3GPE EVMSG3 8N5/0.75 ESPT	0.75	1	59	56.5	54.5	52	44	33.4	-	-	-	-	-	-	1.7	G2	G2	
3GPE EVMSG3 12N5/1.1 ESPT	1.1	1.5	89	84.5	81.5	77.5	65.5	50	-	-	-	-	-	2.5	G2	G2		
3GPE EVMSG5 5N5/1.1 ESPT	1.1	1.5	47.5	-	-	45	42.5	39.9	34.5	25.5	-	-	-	2.5	G2½	G2½		
3GPE EVMSG5 7N5/1.5 ESPT	1.5	2.2	66.5	-	-	63	59.5	56	48.5	35.7	-	-	-	3.3	G2½	G2½		
3GPE EVMSG5 8N5/2.2 ESPT	2.2	3	76	-	-	72	68	64	55	41	-	-	-	4.7	G2½	G2½		
3GPE EVMSG5 10N5/2.2 ESPT	2.2	3	95	-	-	90	88.5	80	69	51	-	-	-	4.7	G2½	G2½		
3GPE EVMSG10 6N5/2.2 ESPT	2.2	3	65.5	-	-	-	-	63.5	62.5	59	56	50	45	29.5	4.7	G3	G3	
3GPE EVMSG10 7N5/3 ESPT	3	4	76.5	-	-	-	-	74	73	69	65.5	58	52	34.4	6.4	G3	G3	
3GPE EVMSG10 8N5/3 ESPT	3	4	87	-	-	-	-	84.5	83.5	79	74.5	66.5	59.5	39.3	6.4	G3	G3	
3GPE EVMSG10 9N5/4 ESPT	4	5.5	98	-	-	-	-	95.5	93.5	89	84	74.5	67	44	8.7	G3	G3	

3GPE EVMSG 15-20

Model	kW x3	HP x3	Q=Flow rate								Input curr. [A] 400V	DNA	DNM		
			l/min	0	390	450	540	600	750	900				1200	1440
			m ³ /h	0	23.4	27	32.4	36	45	54				72	86.4
H=Head [m]															
3GPE EVMSG15 4N5/4 ESPT	4	5.5	59	55	54.5	53	52	50	46.5	33.6	-	8.7	DN100	DN100	
3GPE EVMSG15 6N5/5.5 ESPT	5.5	7.5	88.5	82.5	81.5	79.5	78	74.5	69.5	50.5	-	10.4	DN100	DN100	
3GPE EVMSG20 3N5/4 ESPT	4	5.5	50.5	-	-	46	45	43.4	41.6	35.5	26.2	8.7	DN100	DN100	
3GPE EVMSG20 4N5/5.5 ESPT	5.5	7.5	67.4	-	-	61	60	58	55.4	47.3	34.9	10.4	DN100	DN100	
3GPE EVMSG20 6N5/7.5 ESPT	7.5	10	101	-	-	91.2	90	87	83.1	71	52	13.6	DN100	DN100	

3GPE EVMSG 32-45

Model	kW	HP	Q=Flow rate							Input curr. [A] 400V	DNA	DNM			
			l/min	0	600	1050	1500	1800	2100				2400	2700	3000
			m ³ /h	0	36	63	90	108	126				144	162	180
H=Head [m]															
3GPE EVMSG32 3-0F5/5.5 ESPT ZN	5.5	7.5	63	59	52	43	36.4	28.2	-	-	-	10.4	DN150	DN125	
3GPE EVMSG32 4-0F5/7.5 ESPT ZN	7.5	10	83.5	79	70	58	49.5	38.7	-	-	-	13.6	DN150	DN125	
3GPE EVMSG45 2-0F5/7.5 ESPT ZN	7.5	10	54	-	49	46.5	44.5	41.5	38.1	33.6	28.7	13.6	DN200	DN150	

SPECIFICATIONS

Pressure booster sets with constant pressure control with variable frequency, consisting of 3 multi-stage vertical electric pumps in AISI 304 stainless steel and a cast iron body (EVMSG range), including E-SPD+ inverter devices mounted on the motor. The units are installed on their own galvanised steel base. The protection panel, with 3 suitably sized residual current switch disconnectors, has clean contacts directly connected to the E-SPD+ device for the main connections to the digital inputs and outputs available, without the need to intervene on the inverter devices themselves. The pumps are joined together by means of an intake manifold in AISI 304 stainless steel (in galvanised steel for EVMSG 32-45) and a delivery manifold in AISI 304 stainless steel (in galvanised steel for EVMSG 32-45). The unit is completed with 6 shut-off valves (3 on the intake side and 3 on the delivery side), 3 check valves (on the delivery side), 3 pressure transducers (4-20mA) and 1 analogue pressure gauge. The unit is factory tested and assembled prior to consignment.

SEE ALL THE OPTIONALS ON PAGE 47

Control panels and systems



EP-PRO

ELECTRONIC CONTROL PANELS FOR FIXED SPEED UNITS



Multifunctional electronic control panels range, DOL start, for 1, 2 and 3 surface, submersible or borehole pumps, single phase or three phase, settable for several application as:

- Pressurization
- Drainage
- Emptying
- Filling

The EP PRO control panel series allow, in one solution, to satisfy several application needs.

Moreover, the available wide optional range, allow to expand the control panel features due to several needs

FUNCTIONS

- LCD display for displaying and programming: voltage, current, power factor, hours of operation, number of starts, motor status, alarms, analogue signal and thresholds
- AUTOMATIC - 0 - MANUAL operation buttons
- Language settings (Italian, English, French, German, Russian)
- Anti-seize autotest (programmable)
- Dry running protection with: level probes/ floats/ pressure switches and minimum current
- Free voltage inputs: floats /pressure switches
- Analog Input 4-20 mA or 0-10V
- Unit of measurement analogue signal cm - m - bar
- Emergency start and stop inputs with analogue signal operation mode (can be disabled)
- Clickson thermal pad inputs with automatic reset (can be disabled)
- Inversion of inputs (from normally open to normally closed)
- Automatic reset for minimum current alarm with 4 programmable times
- Activation delay from mains return (can be disabled)
- Predisposition for run capacitors
- Duty standby (can be disabled)
- Changeover motor in case of a fault

CONTROLS

- Electronic control of minimum and maximum voltage
- Electronic control of maximum motor current
- Electronic control of minimum motor current
- Failure or incorrect phase sequence control on power supply input (can be disabled)

ALARMS

- Alarms reported: voltage status, levels, motor overload, minimum motor current, clicson motor
- Alarms history
- Alarms for too many starts/hour (Settable)
- General alarm output contacts

OPTIONAL

- RS485 ModBus module
- Level probes module
- Oil chamber water presence module (Waste water pumps)
- BMS free voltage contacts module
- Buffer battery module

EP-PRO SD

ELECTROMECHANICAL CONTROL PANELS FOR FIXED SPEED UNITS



FUNZIONI

- LCD display for displaying and programming: voltage, current, power factor, hours of operation, number of starts, motor status, alarms, analogue signal and thresholds
- AUTOMATIC - 0 - MANUAL operation buttons
- Language settings (Italian, English, French, German, Russian)
- Anti-seize autotest (programmable)
- Dry running protection with: level probes/ floats/ pressure switches and minimum current
- Free voltage inputs: floats /pressure switches
- Analog Input 4-20 mA or 0-10V
- Unit of measurement analogue signal cm - m - bar
- Emergency start and stop inputs with analogue signal operation mode (can be disabled)
- Clickson thermal pad inputs with automatic reset (can be disabled)
- Inversion of inputs (from normally open to normally closed)
- Automatic reset for minimum current alarm with 4 programmable times
- Activation delay from mains return (can be disabled)

Multifunctional electronic control panels range, Star / Delta start, for 1, 2 and 3 surface, submersible or borehole pumps, single phase or three phase, settable for several application as:

- Pressurization
- Drainage
- Emptying
- Filling

The EP PRO SD control panel series allow, in one solution, to satisfy several application needs.

Moreover, the available wide optional range, allow to expand the control panel features due to several needs

CONTROLLI

- Electronic control of minimum and maximum voltage
- Electronic control of maximum motor current
- Electronic control of minimum motor current
- Failure or incorrect phase sequence control on power supply input (can be disabled)

ALLARMI

- Alarms reported: voltage status, levels, motor overload, minimum motor current, clicson motor
- Alarms history
- Alarms for too many starts/hour (Settable)
- General alarm output contacts

OPTIONAL

- RS485 ModBus module
- Level probes module
- Oil chamber water presence module (Waste water pumps)
- BMS free voltage contacts module
- Buffer battery module

SP-EFC RANGE

CONTROL PANELS WITH INVERTER FOR VARIABLE SPEED UNITS



MAIN FEATURES

- Constant pressure control (default setting)
- Differential pressure control
- Constant level control
- Constant temperature control
- Differential temperature control
- Wastewater pumps control
- chance to force 1 pump in standby (available feature from 2 pumps control panel and over)
- PTC protection or emergency pressure switches control (settable)
- 0-10V Control
- Colors display with moveing icons
- 1 RS485 port for ModBus communication (2nd RS485 port available as option)



Pressure booster sets with SP-EFC panel only available upon request; contact our sales network

TECHNICAL CHARACTERISTICS

- The SP EFC inverter panels control pump one at variable speed and automatically start up any other pumps as necessary to ensure the system pressure is kept at constant values
- This enhances the comfort level, minimises management costs, and reduces the number of air precharge accumulation tanks to the bare minimum

DISPLAY

Colors display with moveing icons

- Information on the front of the panel:
 - setted value (pressure, temperature, level)
 - istant system value (pressure, temperature, level)
 - pump speed controlled by inverter
 - pump number controlled by inverter
 - pumps number on work
 - consumption for each motor / pump
 - total system consumption
 - working hours for each motors / pumps
- Failure type information
 - sensor failure
 - overload for each motors
 - overload invarter (3 autoreset)
 - dry run (3 autoreset),
 - overpressure (autoreset),
 - inverter protection
 - max start time
 - underpressure
 - setting failure
 - dry run protection by minimum power (on the inverter controlled pump)

The pressure units with inverter control panels, SP EFC range, are fitted as standard with emergency pressure switches.

This ensures the system can work in emergency mode, with on-off control of all the pumps installed, in the event of a pressure transducer fault or a fault on the electronic communication board.

To further guarantee system reliability, it is possible to install a second pressure transducer 4-20mA as a backup for the primary one (optional, available upon request).

* Special version, IP55 and 50°C ambient temperature degree, for heavy application available upon request (contact our sales network)

* Special version with RFI harminc filters included, available upon request (contact our sales network)

* Special version for 5 or 6 pumps available upon request (contact our sales network)

SP-MFC RANGE

CONTROL PANELS WITH INVERTER FOR VARIABLE SPEED UNITS



MAIN FEATURES

- Constant pressure control (default setting)
- Differential pressure control
- Constant level control
- Constant temperature control
- Differential temperature control
- Wastewater pumps control
- chance to force 1 pump in standby (available feature from 2 pumps control panel and over)
- PTC protection or emergency pressure switches control (settable)
- 0-10V Control
- Colors display with moveing icons
- 1 RS485 port for ModBus communication (2nd RS485 port available as option)



Pressure booster sets with SP-MFC panel only available upon request; contact our sales network

TECHNICAL CHARACTERISTICS

- The inverter control panels of the SP MFC range control all the pumps in the system at variable speed, ensuring the system pressure is kept at constant values
- This enhances the comfort level, minimises management costs, and reduces the number of air precharge accumulation tanks to the bare minimum

DISPLAY

Colors display with moveing icons

- Information on the front of the panel:
 - setted value (pressure, temperature, level)
 - istant system value (pressure, temperature, level)
 - pump speed controlled by inverter
 - pump number controlled by inverter
 - pumps number on work
 - consumption for each motor / pump
 - total system consumption
 - working hours for each motors / pumps
- Failure type information
 - sensor failure
 - overload for each motors
 - overload invarter (3 autoreset)
 - dry run (3 autoreset),
 - overpressure (autoreset),
 - inverter protection
 - max start time
 - underpressure
 - setting failure
 - dry run protection by minimum power (on the inverter controlled pump)

The pressure units with inverter control panels, SP EFC range, are fitted as standard with emergency pressure switches.

This ensures the system can work in emergency mode, with on-off control of all the pumps installed, in the event of a pressure transducer fault or a fault on the electronic communication board.

To further guarantee system reliability, it is possible to install a second pressure transducer 4-20mA as a backup for the primary one (optional, available upon request).

* Special version, IP55 and 50°C ambient temperature degree, for heavy application available upon request (contact our sales network)

* Special version with RFI harminc filters included, available upon request (contact our sales network)

* Special version for 5 or 6 pumps available upon request (contact our sales network)

E-SPD+

ELECTRONIC INVERTER CONTROL DEVICE WITH VARIABLE SPEED



E-SPD+ is the evolution of the previous E-SPD device which has undergone a design overhaul but, above all, has seen all its technical characteristics updated to better meet varying installation requirements.

The new E-SPD+ is ideal for a variety of installation conditions and operating modes. Designed primarily for installation on the motor, it can also be installed on the wall (using the optional installation kit). Thanks to this accessory, E-SPD+ can even be used with submersible pumps.

The new functions and extension of the range (now available up to 11 kW) more fully satisfy the wide span of application and installation needs.

VERSIONS AVAILABLE

- E-SPD+ 2200
(230V single-phase input, 230V three-phase output)
- E-SPD+ 4000
(400V three-phase input, 400V three-phase output)
- E-SPD+ 11000
(400V three-phase input, 400V three-phase output)

PROTECTION

- Overtemperature (with frequency limiting to ensure service continuity)
- Dry operation
- Excessive pressure drop or pipe fault
- No voltage, or low voltage
- Short-circuiting
- Absent or faulty sensor
- Parameter error
- Overpressure

CHARACTERISTICS AVAILABLE

- Constant pressure control (up to 2 different setpoints)
- Differential pressure control
- Constant temperature control (up to 2 different setpoints)
- Differential temperature control
- Fixed speed control (up to 2 different setpoints)
- 0-10V control (PLC or potentiometer)
- Start and stop programmable via a built-in clock
- 4 configurable digital inputs
- 2 configurable digital outputs
- 2 inputs 4-20mA
- 2 RS 485 ports (1 for ModBus + 1 for communication)
- 1 input 0-10V
- 1 PTC or NTC contact

OPTIONALS

AVAILABLE UPON REQUEST



1" VALVE FOR EXPANSION TANK INSTALLATION

1" MF valve with butterfly handle for installing or connecting an expansion tank on the delivery manifold. The valve allows the tank to be removed more easily if it needs to be serviced and/or replaced.



FLOWTHRU™ VALVE

1" MF FlowThru™ valve for expansion tank installation. Allows total water recirculation in the expansion tank, notably reducing the risk of proliferation of bacteria. Fitted with a drainage valve as well, for the maintenance and/or replacement of the tank.



AIR SUPPLY UNIT AND HOSE

The automatic air supply units are installed on the autoclave tanks to feed the air cushion inside, thereby stabilising the water level. If correctly installed (below the midway point of the tank), they avoid any need to install compressors.

Model

- MINI air supply unit
- MIDI air supply unit
- MAXI air supply unit
- MINI hose ¼ x ½ L 700
- MIDI and MAXI hose ½ x ¾ L 1000



MINIMUM LEVEL FLOAT

Level float (Key range) with counterweight, IP68 protection degree and H07RN-F cable

Model

- 5 m Key float in PVC with counterweight
- 10 m Key float in PVC with counterweight
- 20 m Key float in PVC with counterweight

OPTIONALS

AVAILABLE UPON REQUEST



EXPANSION TANKS

Membrane expansion tanks subjected to rigorous testing and inspections during the entire production process to guarantee their structural rigidity and meet the highest standards in terms of performance and material certification.

Threaded coupling in AISI 304 stainless steel, internal coating in polypropylene to reduce the risk of the membrane breaking, hermetic valve cap sealed with an O-ring.

Model	DNA	DNM
Tank PWB 2-LX 2L 1.9-10 bar 1" GWS	2	1"
Tank PWB 8-LX 8L 1.9-10 bar 1" GWS	8	1"
Tank PWB 18-LX 18L 1.9-10 bar 1" GWS	18	1"
Tank PEB 24-LX 24L 1.9-10 bar 1" GWS	24	1"
Tank MXB-18LX 18L 16 bar 1" GWS	18	1"
Tank MXB-24LX 24L 16 bar 1" GWS	24	1"
Tank UMB-24LX 24L 25 bar 1" GWS	24	1"
Tank PWB 60-LV 60L 1.9-10 bar 1" GWS	60	1"
Tank PWB 80-LV 80L 1.9-10 bar 1" GWS	80	1"
Tank PWB 100-LV 100L 1.9-10 bar 1" GWS	100	1"
Tank PWB 150-LV 150L 1.9-10 bar 1" GWS	150	1"
Tank GCB 200-LV 200L 1.9-10 bar 1 1/4" GWS	200	1 1/4"
Tank GCB 250-LV 250L 1.9-10 bar 1 1/4" GWS	250	1 1/4"
Tank GCB 300-LV 300L 1.9-10 bar 1 1/4" GWS	300	1 1/4"
Tank GCB 450-LV 450L 1.9-10 bar 1 1/4" GWS	450	1 1/4"



AIR INTAKE CONNECTION POINT KIT

Connection point kit for installing air supply units for flanged pressure booster sets

Model	DN	Material
AIR INTAKE CONNECTION POINT KIT DN65 PN16 ZN	65	Galvanised steel
AIR INTAKE CONNECTION POINT KIT DN65 PN16 A304		AISI 304
AIR INTAKE CONNECTION POINT KIT DN65 PN16 A316		AISI 316
AIR INTAKE CONNECTION POINT KIT DN80 PN16 ZN	80	Galvanised steel
AIR INTAKE CONNECTION POINT KIT DN80 PN16 A304		AISI 304
AIR INTAKE CONNECTION POINT KIT DN80 PN16 A316		AISI 316
AIR INTAKE CONNECTION POINT KIT DN100 PN16 ZN	100	Galvanised steel
AIR INTAKE CONNECTION POINT KIT DN100 PN16 A304		AISI 304
AIR INTAKE CONNECTION POINT KIT DN100 PN16 A316		AISI 316

OPTIONALS

AVAILABLE UPON REQUEST



REMOTE ALARM SIGNALLING DEVICE WITH BUFFER BATTERY

Remote alarm signalling devices, UNIT ALARM range, including buffer battery to guarantee continuous operation even during a power failure.

Model	Supply voltage V_{in}	Protection degree	Box material	Dimensions [mm]		
				H	L	W
UNIT ALARM MOD. 1 acoustic	1~230V	IP55	ABS	320	240	190
UNIT ALARM MOD. 2 acoustic + light	1~230V	IP55	ABS	320	240	190
UNIT ALARM MOD. GSM	1~230V	IP55	ABS	320	240	190



REMOTE ALARM SIGNALLING DEVICE WITHOUT BUFFER BATTERY

Remote alarm signalling devices, FLASH range, including 90 dB acoustic signal and indicator light

Model	Supply voltage V_{in}	Protection degree	Box material	Dimensions [mm]		
				H	L	W
FLASH MOD. 12 acoustic + light	12V	IP55	ABS	210	120	150
FLASH MOD. 24 acoustic + light	24V	IP55	ABS	210	120	150
FLASH MOD. 220 acoustic + light	1~ 230V	IP55	ABS	210	120	150

Technical information

GP-GPE PRESSURE BOOSTER SETS

DEFINITION AND USE OF THE PRESSURE BOOSTER SETS

If the public water distribution system is non-existent, or insufficient for the correct functioning of equipment, it is necessary to install a pressure booster set to guarantee an acceptable water quantity and pressure even in the most penalised points. Pressure booster sets are used wherever the pressure needs to be increased or the water supply needs to be kept pressurised. EBARA's GP pressure booster sets are small, automatic systems with 2 pumps or more working in parallel. They are designed and built to meet the most common water pressure maintenance requests in a simple and reliable way in blocks of flats, hotels, centres, offices and schools, and for auxiliary services in the industrial and agricultural context.

They stand out for their robustness, compact design, high performance and quiet operation.

The GP units are designed to be connected to membrane or air cushion pressure tanks.

Pump start-up is controlled by a 4-20mA pressure transducer or by suitably calibrated pressure switches (activated from an electric control panel).

OPERATING PRINCIPLE OF THE GP PRESSURE BOOSTER SET

When water is requested, it is initially taken from the autoclave tank. This water consumption (or in any case the removal of water from the system), with the pumps stationary, lowers the pressure until it reaches a value where the control system (pressure transducer or pressure switches) intervenes to activate the first electric pump. If the outward flow is greater than the flow rate of one pump, the pressure continues to fall and so the second pump is activated as well (in cascade).

This applies to all the electric pumps that make up the unit.

When the outward water flow stops or diminishes, the pressure level rises; this gradually stops all the pumps that are working, until the whole unit has stopped completely.

The reversal of the motor activation order reduces the number of hourly start-ups of the individual pumps, which means they are all used to the same degree.

N.B. By connecting a float or minimum pressure switch to the panel (for taking water both from the primary tank and from the hydraulic circuit), the most common cause of electric pump failure - a lack of intake water - can be avoided.

OPERATING PRINCIPLE OF THE GPE PRESSURE BOOSTER SET

The GPE units, with E-SPD+, are designed to start up each single pump with an inverter device installed on the motor.

GPE units with E-SPD+ keep a constant pressure value in the water supply and also optimise energy consumption and pump wear, lengthening the pump lifespan and reducing the need for maintenance.

When the pressure changes, the first pump is activated with a controlled acceleration ramp. The inverter device modulates the motor speed to vary pump performance, thereby controlling and maintaining the required pressure level in the system. If the water request exceeds the capacity of the pump that has been activated, the second pump will begin working as well. The speed of both pumps is synchronised by the relative inverter devices to optimise the work load and stabilise the system pressure.

In pressure booster sets with E-SPD+, 2 different pressure values can be set; the switchover between the 2 is managed by the switching of a digital input that can be controlled via an external command such as a pressure switch, a standard switch, or a control unit (e.g. irrigation). This function allows two pressure values to be controlled with the same unit.

Technical information

GP-GPE PRESSURE BOOSTER SETS

CONDITIONS OF USE

The standard versions of the EBARA GP-GPE pressure booster sets can be used for domestic, industrial and agricultural applications, and in particular for:

- lifting or moving water
- air conditioning
- heating
- irrigation
- washing systems

The pumped liquid may be clean water, drinking water, rainwater, groundwater, mixed water, or in any case free of solid bodies or suspended fibres and free of aggressive chemical substances. The units must be installed in a covered place and protected from bad weather and freezing temperatures.

- The temperature of the pumped water must respect the limits of the pump in question.
- The ambient operating temperature is 0°-40°C at a maximum altitude of 1000m above seal level.
- Maximum relative humidity 50% at +40°C.

N.B. It is useful to remember that the intake height (negative suction head installation) falls as the altitude and temperature increase. These characteristics, on the basis of the pump NPSH (see page 54), must be taken into consideration when sizing a system in order to avoid cavitation or insufficient productivity: the system NPSH available must be greater than the NPSH requested by the pump. For applications with different technical characteristics, types of use or weather conditions (type of liquid pumped, marine environment, aggressive industrial applications), contact our sales network.

2-PUMP UNIT WITH CONSTANT PRESSURE ADJUSTMENT

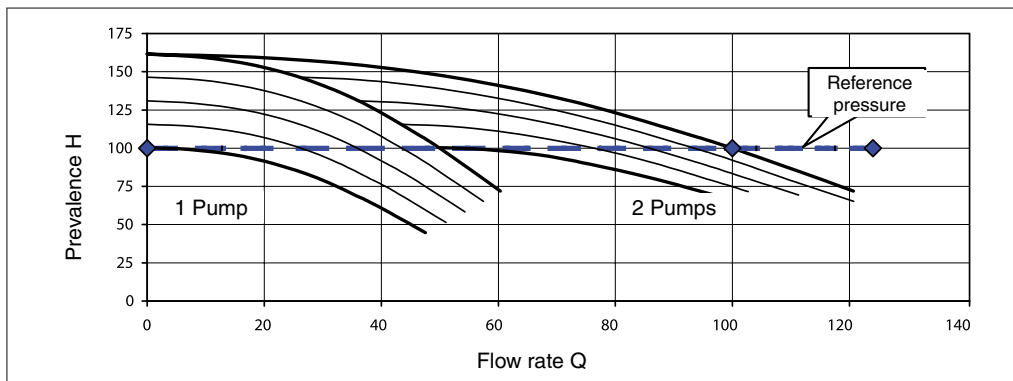

2-PUMP UNIT WITH PRESSURE ADJUSTMENT BASED ON TWO SETTINGS

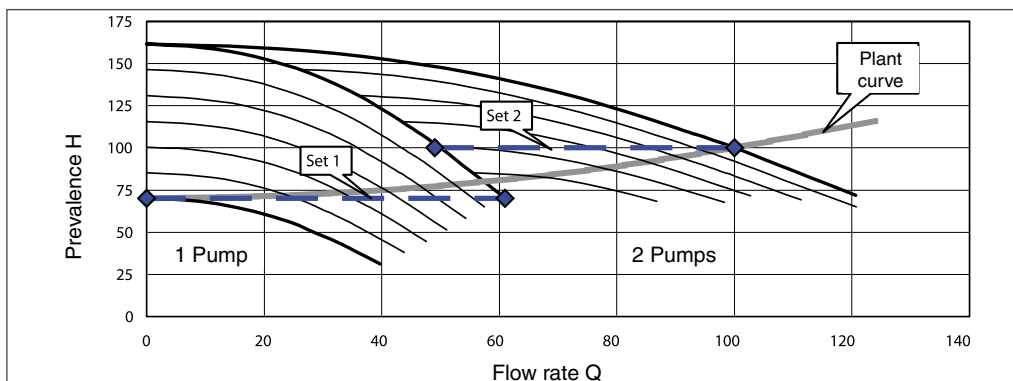

Technical information

GP-GPE PRESSURE BOOSTER SETS

CONDITIONS OF USE

The pressure booster sets are supplied complete with:

- electric pumps
- a pressure gauge
- a pressure transducer or pressure switches (depending on the model)
- intake and delivery manifolds
- shut-off valves on intake and delivery
- check valves on the intake side for fixed speed GP units, and on the delivery side for variable speed GPE units
- miscellaneous fittings
- a control panel or device
- a single base
- anti-vibration supports (not on all sizes)

GENERAL TESTS AND ACCEPTANCE TESTS

All EBARA pressure booster sets are subjected to hydraulic, mechanical and electrical tests before being packaged.

HYDRAULIC AND MECHANICAL TESTS

- Calibration of pressure switches (if fitted)
- Check of pump rotation direction
- Mechanical testing of moving parts, and noise check (on each pump)
- Seal test with delivery inlet closed, and check of rated head value
- Operating test in MANUAL mode (using the button on the electric panel) for each single pump
- Operating test in AUTOMATIC mode (using the switch on the electric panel) for the unit

ELECTRIC TESTS

- Earth circuit continuity check
- Test with applied voltage
- Insulation resistance test

CONTROL
DEVICE

CENTRIFUGAL
ELECTRIC PUMPS

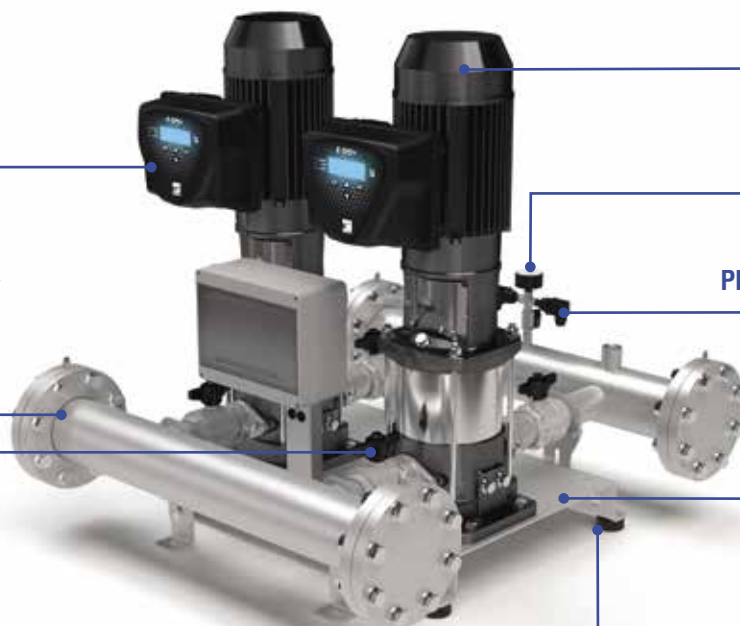

PRESSURE GAUGE

INTAKE AND DELIVERY
MANIFOLDS

PRESSURE TRANSDUCER

SINGLE BASE

SHUT-OFF VALVES
ON INTAKE AND DELIVERY

ANTI-VIBRATION SUPPORT

Technical information

GP-GPE PRESSURE BOOSTER SETS

HYDRAULIC LAYOUT OF THE FIXED SPEED GP PRESSURE BOOSTER SET

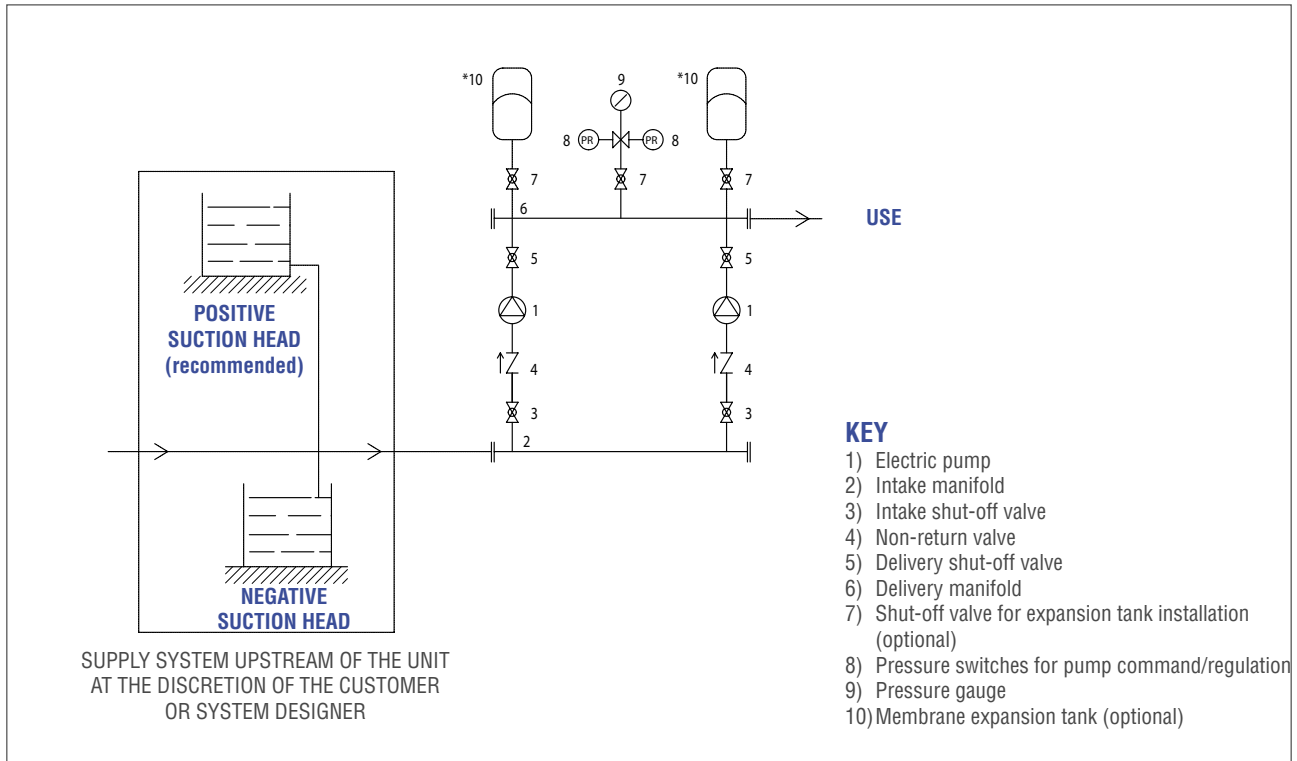

HYDRAULIC LAYOUT OF THE VARIABLE SPEED GPE PRESSURE BOOSTER SET

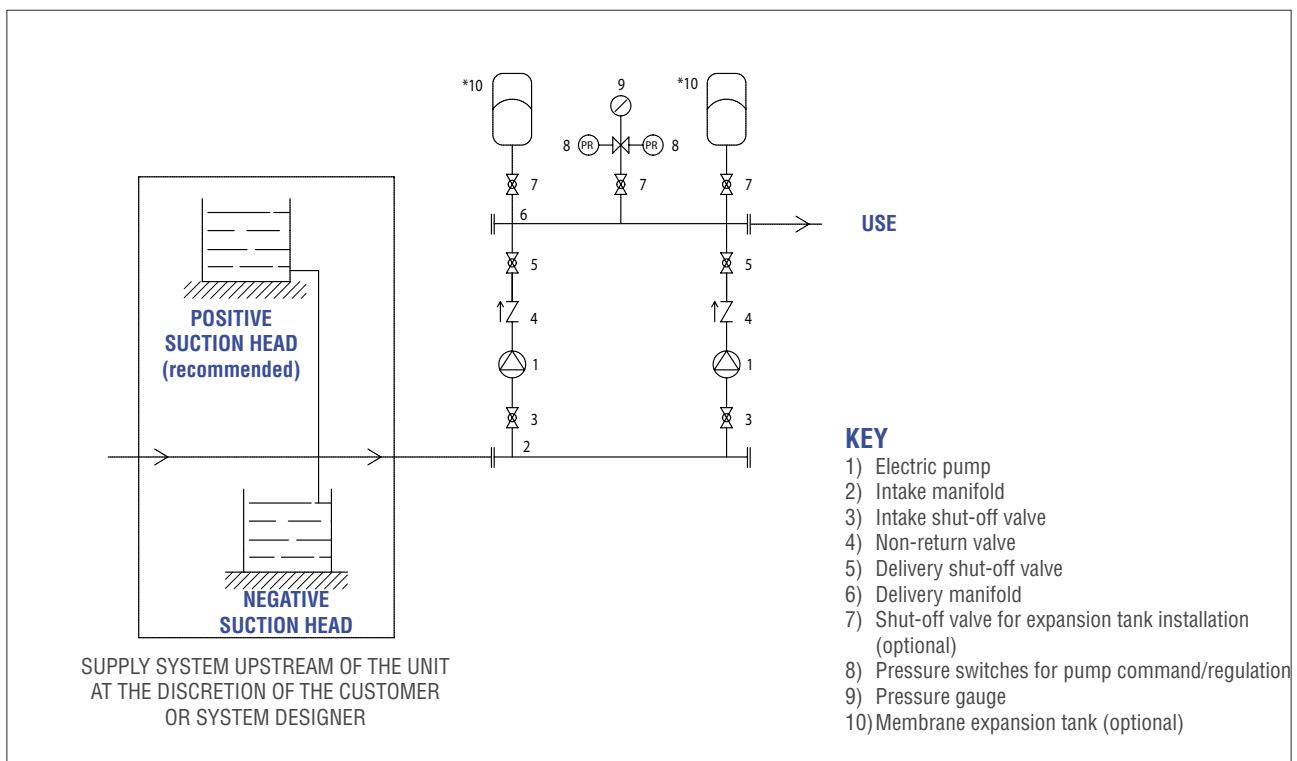

Technical information

GP-GPE PRESSURE BOOSTER SETS

CHOOSING A PRESSURE BOOSTER SET

- When choosing the unit, take into account the maximum flow rate (Q) and head (H) values that the water system will require during operation, especially in the most highly penalised point of use.
- To avoid operation outside the performance curve, and purchase and running costs higher than expected, the pressure booster set must not be oversized.
- When sizing the system and choosing the unit, apply the basic criteria of economics and energy savings (e.g. water consumption, usage time, electricity).
- The unit operating point at the maximum flow rate envisaged must not correspond to its maximum productivity point; it must be further to the right so that, in normal operating conditions (at a lower flow rate), the productivity is still high.
- To avoid cavitation, it is advisable to make sure that the unit operating point at the maximum flow rate is not in the area where the NPSH bend increases rapidly, or outside that area.

NPSH (NET POSITIVE SUCTION HEAD)

A pump installed above the surface of the water can “suck in” the water using the effect of the atmospheric pressure on the surface itself; this pressure corresponds to approximately 10 m of water column. This means that, however great the intake capacity of a pump, the height from which it can suck in water is always limited to 10 m. In reality however, the limit is lower than this owing to the pressure drop in the intake tube, the kinematic height of the current, and the dynamic effect of the pump impeller. Attempting to take in water beyond these limits will give rise to the phenomenon of cavitation in the pump, which not only seriously damages the pump components but also prevents any increase in the flow rate.

Cavitation involves the sudden formation and collapse of cavities, formed mainly of vapour, during the flow of a liquid. These cavities build up in areas where, at the operating temperature, the pressure of the liquid is close to the vapour pressure at that temperature. In the case of centrifugal pumps, the phenomenon occurs mainly at the point of entry of the impeller blades, where the sudden acceleration of the current reduces the pressure level. The vapour cavities that form are transported by the flow and then implode in the areas where the pressure of the liquid rises again. The implosion of the vapour

bubbles is accompanied by a pressure wave that creates a shock or hammering effect on the surfaces involved. This can produce phenomena of fatigue and plastic deformation, and the removal of material from the surface. The effect may be speeded up by the corrosive action of the fluid processed by the pump.

To characterise the behaviour of a pump in the case of cavitation, the NPSH (Net Positive Suction Head) value is determined. It represents the height, or absolute load (net of the liquid vapour tension) that must be present during pump intake in order to avoid cavitation.

It is immediately clear how important it is to make sure that the net absolute height available in the system (available NPSH) is greater (by at least 1m) than that requested by the pump. The available NPSH is calculated with the formula:

$$\text{NPSH} = z_1 + \frac{p_0}{\gamma} - H_{r1} + \frac{p_b - p_v}{\gamma}$$

Where:

z_1 = level difference (in m) between the axle of the pump intake point and the surface of the liquid in the supply tank, and which will be: **negative** in the case of operation under the head, or **positive** with operation above the head

p_0 = any possible relative pressure (in Pa) on the surface of the liquid in the supply tank. If the intake is from an “open” tank (i.e. in contact with the atmosphere), p_0 is equal to 0

γ = the specific weight of the liquid (in N/m³) at the pumping temperature

H_{r1} = pressure drops (in m) on the whole intake duct

p_b = barometric pressure (in Pa) in the system where the pump is installed

p_v = vapour tension (in Pa) of the liquid at the pumping temperature

Technical information

GP-GPE PRESSURE BOOSTER SETS

Reduction of the level difference during intake, with variations in the temperature of the water

Temperature °C	Intake drops in metres (kt)
25	0
30	0.4
40	0.8
50	1.3
60	2.0
70	3.2
80	4.8
90	7.1

Reduction of the level difference during intake, based on the position above sea level

Position m	Intake drops in metres (kt)
0	0
500	0.55
1000	1.1
1500	1.65
2000	2.2
2500	2.75
3000	3.3

DETERMINING THE FLOW RATE (Q)

This is the amount of fluid that passes through a cross-section with area “A” within the set time. The first data item to be calculated when sizing a pressure booster set is the total quantity of water that must be supplied in order to meet the maximum theoretical need (i.e. the total of the water consumption values in each supply point).

The table shows the maximum simultaneous water flow rate values per number of flats with 1 or 2 toilets with cisterns.

No. of flats	Toilets with cisterns	
	1 Flow rate (l/min)	2 Flow rate (l/min)
1	30	40
2	40	55
3	52	65
4	60	75
5	70	85
6	75	90
7	80	100
8	85	110
9	90	115
10	95	120
11	100	130
12	105	135
13	110	140
14	115	145
15	120	150
16	125	155
17	130	160
18	135	165
19	140	170
20	145	175
22	150	180
24	155	185
26	160	190
28	165	195
30	170	200
32	175	205
34	180	210
36	185	220
38	190	230
40	195	240
45	205	260
50	215	270
55	225	280
60	235	290
65	245	300
70	255	310
75	265	320
80	275	330
85	280	340
90	285	350
95	290	360
100	300	380
110	315	400
120	330	420
130	345	440
140	360	460
150	375	480
160	390	500
170	405	520
180	420	540
190	435	560
200	450	580
220	465	600
240	480	620
260	495	640
280	510	660
300	525	680
320	540	700
340	555	720
360	570	740
380	585	760
400	600	780

NB: in the case of seaside areas, the flow rate is 20% higher

Technical information

GP-GPE PRESSURE BOOSTER SETS

DETERMINING THE HEAD (H)

The head is the maximum lifting level difference (in relation to the point where a fluid is picked up) to which a pump can push that fluid.

It includes the level difference between the pump and the extraction basin (if the latter is at a lower level), plus the level difference between the pump and the destination basin higher up. The path followed by the tubes has no effect on the level difference that can be travelled, as this depends entirely on the difference in the piezometric position between the intake liquid surface and the depositing one. The head is commonly expressed as metres of water. Pump head is the energy - per unit of weight - applied to the fluid by the pump. In a closed circuit, the head is used to overcome the pressure drops in the circuit, caused by friction.

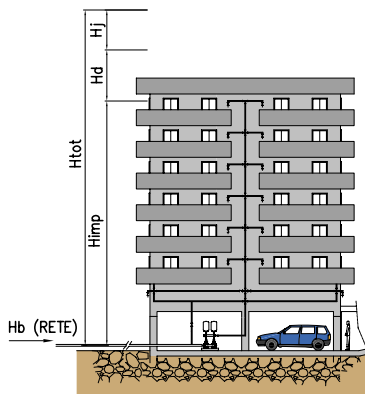

$$H_{tot} = H_{imp} + H_d + H_j$$

Example: $H_{imp} = 20$
 $H_d = 15$
 $H_j = 2$
 $H_{tot} = 20 + 15 + 2 = 37$

H_{imp} = geodetic height from the pump intake axle to the highest service point
 H_d = geodetic height at the minimum pressure required at the highest service point
 H_j = total of the continuous and localised pressure drops

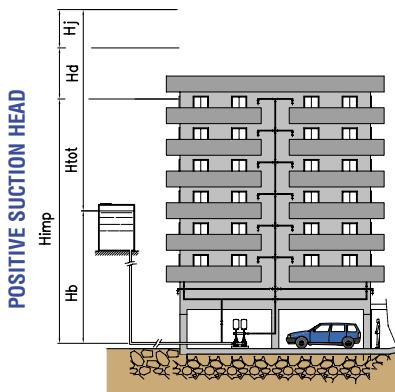

$$H_{tot} = H_{imp} - H_b + H_d + H_j$$

Example: $H_{imp} = 20$
 $H_b = 15$
 $H_d = 15$
 $H_j = 2$
 $H_{tot} = 20 - 15 + 15 + 2 = 22$

H_{imp} = geodetic height from the pump intake axle to the highest service point
 H_b = geodetic height under head, or height corresponding to the minimum mains water pressure
 H_d = geodetic height at the minimum pressure required at the highest service point
 H_j = total of the continuous and localised pressure drops

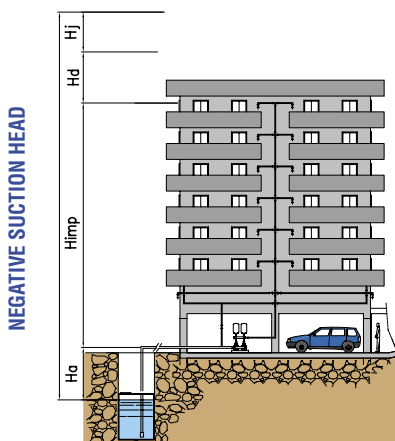

$$H_{tot} = H_{imp} + H_a + H_d + H_j$$

Example: $H_{imp} = 20$
 $H_a = 5$
 $H_d = 15$
 $H_j = 2$
 $H_{tot} = 20 + 5 + 15 + 2 = 42$

H_{imp} = geodetic height from the pump intake axle to the highest service point
 H_a = geodetic height above head
 H_d = geodetic height at the minimum pressure required at the highest service point
 H_j = total of the continuous and localised pressure drops

Technical information

PRESSURE DROPS

This is the resistance of the fluid as it comes into contact with the walls of a pipe or close to variations in pipe diameter or at the intersection with bends and valves in the system. It is also affected by the fluid temperature and the geodetic height of the system. Generally speaking, it is expressed as metres of water column.

Pressure drops (Pc) in metres of water column for every hundred metres of new cast iron pipe.

Speed of the liquid in the pipes, in metres/second.

Flow rate		Internal diameter [mm]																										
m³/h	l/min	25	32	40	50	60	70	80	90	100	125	150	175	200	225	250	275	300	350	400	450	500	600	700	800	900	1000	
3	50	Pc % Vm/s	17 1.70	6 1.03	1.6 0.67	0.54 0.43	0.25 0.29	0.13 0.22	0.06 0.16	0.03 0.13	0.02 0.10																	
6	100	Pc % Vm/s		24 2.06	6 1.34	2 0.85	0.9 0.58	0.43 0.44	0.21 0.32	0.13 0.26	0.08 0.20	0.026 0.13																
9	150	Pc % Vm/s			12.5 2.08	4.3 1.32	1.8 0.89	0.9 0.65	0.46 0.5	0.25 0.39	0.15 0.32	0.06 0.20																
12	200	Pc % Vm/s			20 2.76	7 1.19	3.2 1.19	1.5 0.88	0.75 0.67	0.44 0.53	0.25 0.43	0.09 0.27	0.03 0.18															
15	250	Pc % Vm/s				12 2.2	5.2 1.49	2.4 1.1	1.25 0.87	0.7 0.66	0.42 0.54	0.15 0.34	0.06 0.24															
18	300	Pc % Vm/s				17 2.64	7 1.78	3.5 1.3	1.7 1	1 0.78	0.6 0.64	0.2 0.4	0.08 0.28															
21	350	Pc % Vm/s				22 3.35	8.8 1.54	4.2 1.17	2.2 1.3	1.3 0.93	0.75 0.75	0.26 0.48	0.1 0.32	0.05 0.24														
24	400	Pc % Vm/s					12 2.38	5.7 1.76	3 1.34	1.7 1.06	1 0.86	0.36 0.54	0.14 0.36	0.07 0.28														
27	450	Pc % Vm/s					14 2.7	7 1.97	3.5 1.45	2 1.17	1.25 0.96	0.42 0.6	0.17 0.42	0.08 0.31														
30	500	Pc % Vm/s					17 2.98	8.2 2.2	4.2 1.74	2.5 1.32	1.5 1.08	0.5 0.68	0.2 0.48	0.09 0.34														
36	600	Pc % Vm/s					25 3.58	12 2.63	6.3 2	3.5 1.58	2 1.28	0.75 0.82	0.3 0.57	0.14 0.42	0.07 0.32													
42	700	Pc % Vm/s						16 3.07	8.5 2.34	4.5 1.85	2.7 1.5	0.85 0.96	0.33 0.66	0.18 0.48	0.08 0.37													
48	800	Pc % Vm/s						21 3.51	10 2.68	6 2.12	3.6 1.72	1.2 1.08	0.45 0.56	0.12 0.43	0.06 0.34													
54	900	Pc % Vm/s						25 3.94	13.5 3	7.6 2.34	4.5 1.92	1.5 1.2	0.55 0.84	0.28 0.63	0.14 0.48	0.08 0.38												
60	1000	Pc % Vm/s						16 3.32	9 2.64	5.5 2.16	1.8 1.36	0.7 0.96	0.33 0.68	0.17 0.53	0.1 0.42													
75	1250	Pc % Vm/s						24 4.17	14 3.31	8 2.68	2.76 1.72	1 1.18	0.49 0.87	0.24 0.67	0.14 0.53	0.08 0.43												
90	1500	Pc % Vm/s						20 3.97	12.5 3.24	3.8 2.04	1.45 1.44	0.74 1.02	0.36 0.8	0.2 0.63	0.14 0.51	0.08 0.42												
105	1750	Pc % Vm/s						26 4.6	16.5 3.74	5.3 2.41	1.95 1.66	0.9 1.22	0.47 0.93	0.27 0.74	0.16 0.59	0.1 0.49												
120	2000	Pc % Vm/s						21.5 4.31	6.9 2.72	2.6 1.93	1.2 1.35	0.61 1.06	0.36 0.84	0.2 0.68	0.14 0.56	0.08 0.47												
135	2250	Pc % Vm/s						26 4.81	9 3.07	3.3 2.13	1.5 1.56	0.76 1.19	0.45 0.95	0.25 0.76	0.17 0.63	0.1 0.53												
150	2500	Pc % Vm/s						11 3.44	4 2.36	1.9 1.74	0.95 1.34	0.55 1.05	0.3 0.86	0.21 0.70	0.12 0.59	0.06 0.43												
165	2750	Pc % Vm/s						13 3.75	4.7 2.61	2.2 1.91	1.13 1.46	0.65 1.15	0.37 0.94	0.24 0.77	0.15 0.65	0.08 0.48												
180	3000	Pc % Vm/s						15.2 4.09	5.5 2.83	2.6 2.08	1.3 1.59	0.76 1.26	0.43 1.02	0.29 0.84	0.18 0.71	0.09 0.52												
210	3500	Pc % Vm/s						21 4.70	7.4 3.32	3.5 2.43	1.8 1.86	1.1 1.49	0.6 0.98	0.37 0.82	0.24 0.61	0.12 0.47	0.06 0.48											
240	4000	Pc % Vm/s						9.4 3.78	4.3 2.77	2.3 2.12	1.3 1.68	0.75 1.36	0.48 1.12	0.3 0.95	0.15 0.69	0.08 0.53												
270	4500	Pc % Vm/s						12 4.26	5.5 3.13	2.8 2.39	1.62 1.90	0.9 1.53	0.58 1.28	0.35 1.07	0.18 0.78	0.09 0.59												
300	5000	Pc % Vm/s						14 4.75	7.5 3.47	3.4 2.66	2 1.71	1.1 1.40	0.74 1.40	0.46 1.18	0.22 0.86	0.11 0.53	0.07 0.53											
360	6000	Pc % Vm/s						9 4.15	4.7 3.17	2.8 2.53	1.6 2.04	1 1.68	0.65 1.41	0.32 1.04	0.16 0.79	0.09 0.63	0.05 0.51											
420	7000	Pc % Vm/s						11.6 4.86	6.2 3.72	3.5 2.94	2 1.96	1.3 1.64	0.82 1.22	0.41 1.22	0.21 0.94	0.12 0.76	0.07 0.59	0.03 0.41										
480	8000	Pc % Vm/s							8.5 4.24	4.9 3.36	2.9 2.72	1.9 2.24	1.2 1.90	0.6 1.38	0.3 1.06	0.17 0.84	0.09 0.69	0.04 0.47										
540	9000	Pc % Vm/s							11 4.78	6.5 3.80	3.7 3.06	2.35 2.52	1.52 2.13	0.75 1.75	0.38 1.19	0.22 0.94	0.12 0.76	0.05 0.53										
600	10000	Pc % Vm/s							12.2 5.30	7.4 4.20	4.3 3.40	2.7 2.81	1.7 2.36	0.9 1.73	0.45 1.34	0.25 1.06	0.13 0.86	0.055 0.61	0.024 0.44									
660	11000	Pc % Vm/s							9 4.61	5.2 3.76	3.3 3.07	2.1 2.59	1.1 1.89	0.54 1.46	0.3 1.03	0.16 0.93	0.06 0.65	0.03 0.48										
720	12000	Pc % Vm/s							10 5.05	6 4.08	3.8 3.37	2.5 2.84	1.3 2.08	0.82 1.65	0.52 1.26	0.35 1.02	0.19 0.71	0.075 0.52	0.035 0.52									
780	13000	Pc % Vm/s								7.3 4.43	4.5 3.65	3 3.08	1.5 2.26	0.75 1.73	0.42 1.36	0.23 1.11	0.08 0.77	0.04 0.56										
840	14000	Pc % Vm/s								8 4.76	5.4 3.95	3.4 3.31	1.7 2.43	0.85 1.86	0.48 1.47	0.26 1.19	0.1 0.83	0.01 0.67	0.047 0.51									
900	15000	Pc % Vm/s								9 5.1	5.8 4.22	3.75 3.54	1.9 2.60	0.96 1.57	0.53 1.27	0.29 1.02	0.11 0.88	0.053 0.65										
960	16000	Pc % Vm/s									6.5 4.49	4.3 3.78	2.1 2.77	1.1 1.68	0.6 1.36	0.32 1.02	0.12 0.71	0.06 0.51										
1020	17000	Pc % Vm/s									7.2 4.76	4.6 4.01	2.45 2.94	1.2 1.44	0.67 1.44	0.35 1.02	0.14 0.77	0.065 0.54										
1080	18000	Pc % Vm/s										5.4 4.26	2.8 3.12	1.4 1.86	0.78 1.53	0.43 1.06	0.16 0.78	0.073 0.57	0.037 0.52									
1140	19000	Pc % Vm/s										6 4.49	3.2 3.29	1.53 2.53	0.86 1.69	0.46 1.15	0.175 0.84	0.08 0.61	0.043 0.52	0.037 0.52								
1200	20000	Pc % Vm/s										6.5 4.72	3.4 3.45	1.7 2.12	0.93 1.72	0.5 1.23	0.19 0.88	0.046 0.63	0.04 0.54	0.025 0.4								

It is possible to estimate the pressure drops caused by the accessories using the following comparisons:

- Foot valve: equal to 15 m of piping
- Non-return valve: equal to 10 m of piping
- Gate valve: equal to 5 m of piping
- Bends and elbows: equal to 5 m of piping

For pipes other than new cast iron ones, multiply the data in the table by the following coefficients:

- stainless steel 0.8
- PVC 0.7
- gres (stoneware) 1.17
- sheet steel 0.8
- galvanised steel 0.8
- slightly rusty pipes 1.25
- very rusty, encrusted pipes 2.1

☐ Recommended delivery diameter

☐ Recommended intake diameter

Technical information

PRESSURE DROPS

BALL VALVE LEVER HANDLE

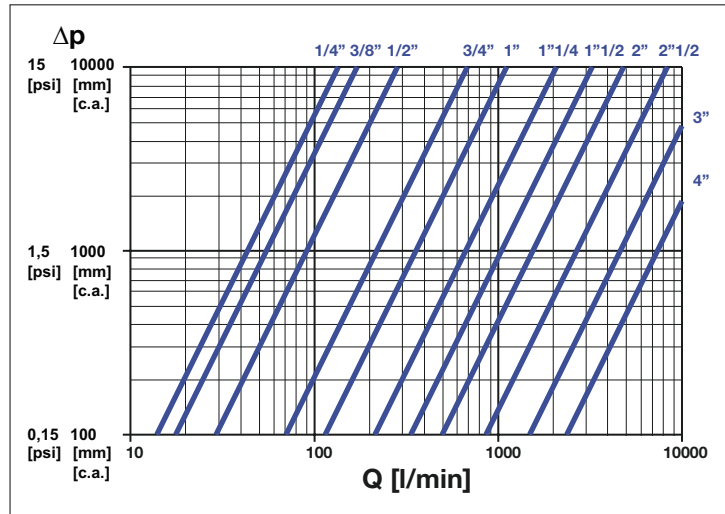

BALL VALVE BUTTERFLY HANDLE

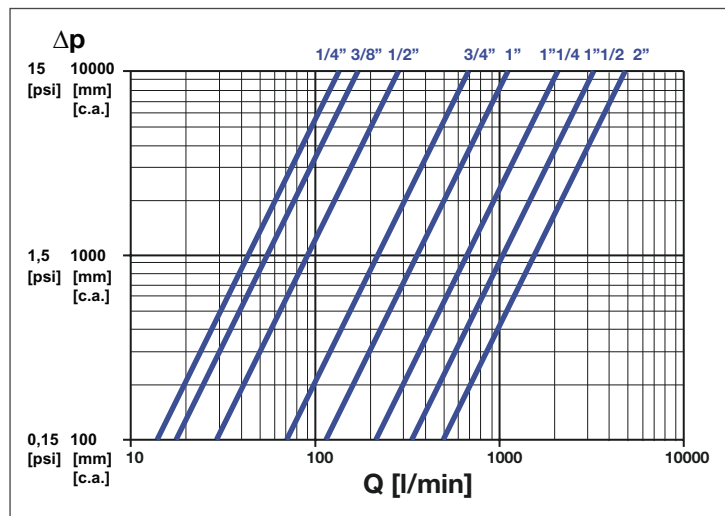

BALL VALVE WITH PIPE UNION BUTTERFLY HANDLE

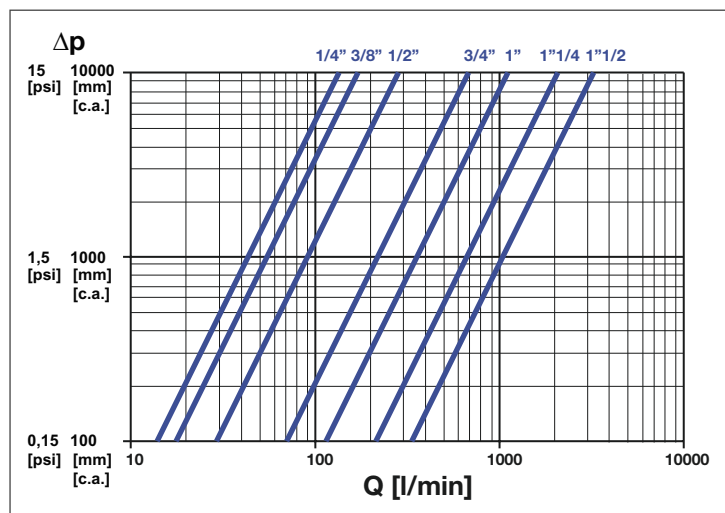

Technical information

PRESSURE DROPS

CHECK VALVE WITH SPRING DISC

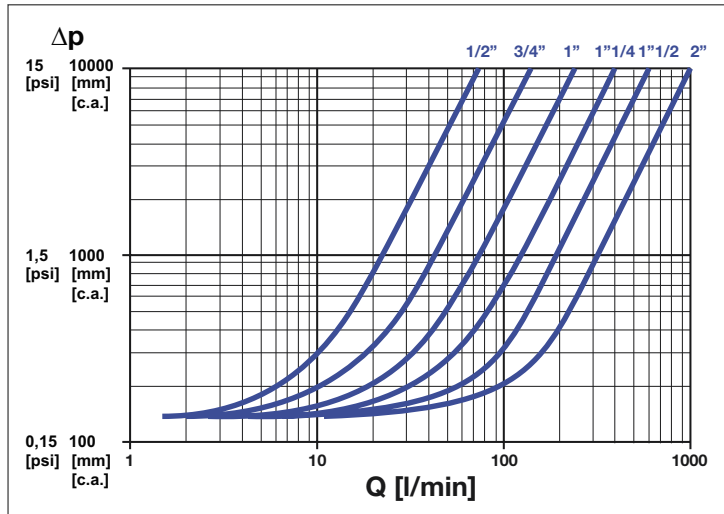

"SPRINT" CHECK VALVE WITH SPRING DISC

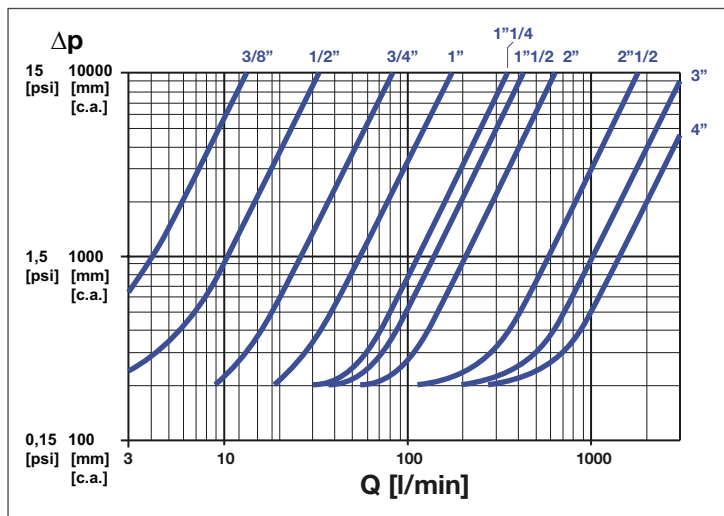

Technical information

PRESSURE DROPS

CHECK VALVE WITH AXIAL GUIDE

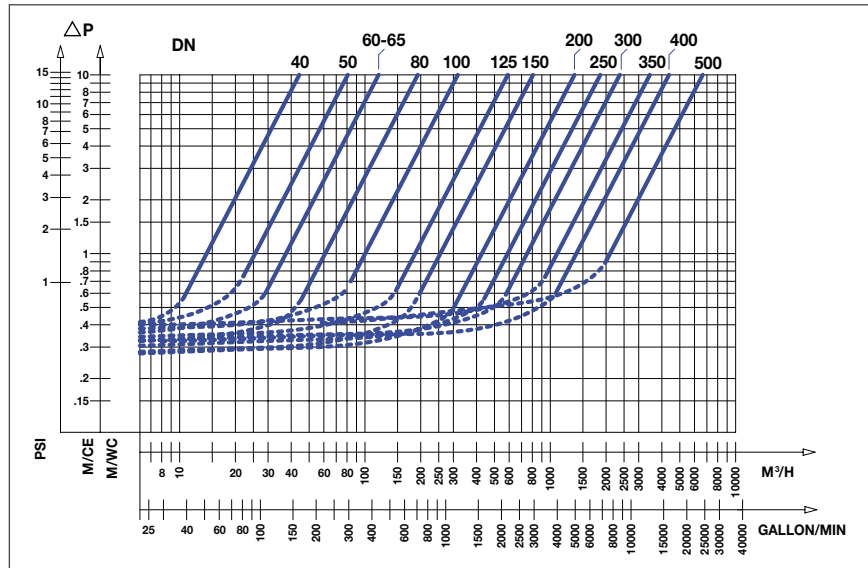



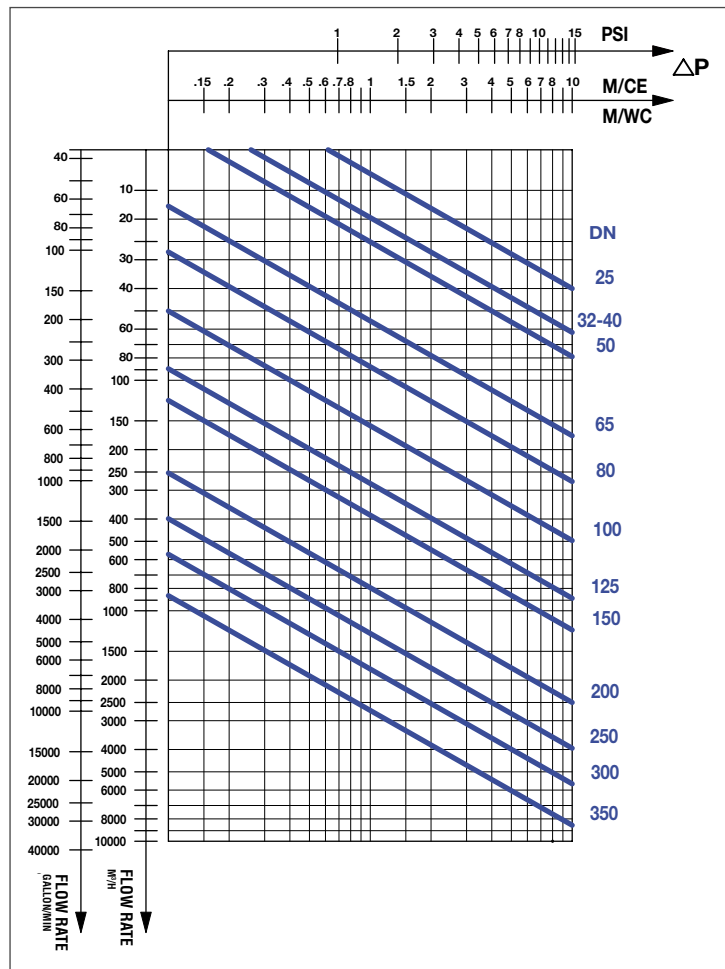

















BUTTERFLY VALVE IN CAST IRON



Technical information

PRESSURE DROPS

PRESSURE DROP WITH REFERENCE TO THE EQUIVALENT PIPE LENGTH IN METRES OF GALVANISED STEEL PIPE

DN	1/4	3/8	1/2	3/4	1	1 1/4	1 1/2	2	2 1/2	3	4	5	6
	0.23	0.35	0.47	0.7	0.94	1.17	1.41	1.88	2.35	2.82	3.76	4.7	5.64
	0.22	0.33	0.44	0.67	0.86	1.11	1.33	1.78	2.23	2.68	-	-	-
	-	0.16	0.22	0.32	0.43	0.54	0.65	0.86	1.08	1.30	1.73	2.16	2.59
	-	0.61	0.81	1.22	1.63	2.03	2.44	3.25	-	-	-	-	-
	-	-	0.27	0.41	0.55	0.68	0.82	1.04	1.37	1.64	2.18	-	-
	0.16	0.24	0.32	0.48	0.64	0.79	0.95	1.27	1.59	1.91	2.54	-	-
	-	0.28	0.34	0.5	0.67	0.84	1.01	1.35	1.68	2.02	2.96	-	4.04
	0.1	0.15	0.2	0.3	0.41	0.51	0.61	0.81	1.02	1.22	-	-	-
	-	-	0.43	0.65	0.86	1.08	1.3	1.73	-	-	-	-	-
	0.04	0.06	0.08	0.12	0.17	0.21	0.25	0.33	0.41	0.5	0.66	0.83	0.99
	0.34	0.51	0.69	1.03	1.37	1.71	2.06	2.74	3.43	4.11	5.49	6.86	8.23
	0.42	0.62	0.83	1.25	1.66	2.08	2.5	3.33	4.16	4.99	6.65	8.32	9.98
	-	-	0.09	0.13	0.18	0.22	0.27	0.36	0.44	0.55	0.73	-	-
	-	-	0.44	0.66	0.88	1.1	1.31	1.75	2.19	2.7	3.51	-	-
	0.05	0.08	0.1	0.15	0.2	0.25	0.3	0.41	0.49	0.59	-	-	-
	0.34	0.5	0.67	1.01	1.35	1.68	2.02	2.69	3.36	4.02	-	-	-
	-	-	0.28	-	-	-	-	-	-	-	-	-	-
	-	-	0.30	-	-	-	-	-	-	-	-	-	-
	0.01	0.01	0.01	0.01	0.01	0.01	0.01	0.01	0.01	0.01	0.02	0.02	0.03
	0.01	0.01	0.01	0.01	0.01	0.01	0.01	0.01	0.01	0.01	0.01	-	-

Technical information

PRESSURE DROPS

LOCALISED PRESSURE DROPS

PRESSURE DROPS DUE TO SUDDEN WIDENING, IN METRES OF WATER COLUMN

DN = Nominal pipe diameter

Di = Real internal pipe diameter

For the continuous pressure drops in the cone, consider an equivalent length of pipe with diameter DN1 equal to L.

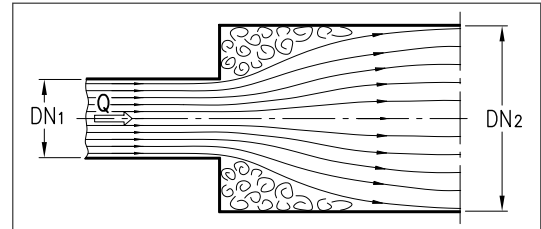

Flow rate Q [m³/h]	DN1	25			32			40			50			65			80			100			125			150			200
	Di1	27.4	27.4	27.4	36.1	36.1	36.1	42.0	42.0	42.0	53.1	53.1	53.1	68.8	68.8	68.8	80.8	80.8	80.8	105.1	105.1	105.1	206.5	206.5	206.5	155.2	155.2	206.5	
	DN2	32	40	50	40	50	65	50	65	80	65	80	100	80	100	125	100	125	150	125	150	200	150	200	250	200	250	250	
Di2	36.1	42.0	53.1	42.0	53.1	68.8	53.1	68.8	80.8	68.8	80.8	105.1	80.8	105.1	129.7	105.1	129.7	155.2	129.7	155.2	206.5	155.2	206.5	260.4	206.5	260.4	260.4		
3		0.02	0.03	0.05		0.01	0.02		0.01	0.01																			
6		0.07	0.13	0.22	0.01	0.04	0.07	0.01	0.03	0.04		0.01	0.02																
9		0.16	0.30	0.49	0.02	0.09	0.16	0.02	0.07	0.09	0.01	0.02	0.04					0.01											
12		0.29	0.54	0.88	0.04	0.16	0.28	0.04	0.12	0.16	0.02	0.04	0.06					0.01	0.02										
15		0.46	0.84	1.37	0.06	0.24	0.44	0.06	0.18	0.25	0.03	0.06	0.10					0.02	0.03										
18		0.66	1.21	1.97	0.08	0.35	0.64	0.09	0.26	0.35	0.04	0.08	0.14	0.01	0.03	0.05	0.01	0.02	0.03								0.01		
21		0.90	1.65	2.69	0.11	0.48	0.87	0.13	0.36	0.48	0.06	0.11	0.20	0.01	0.04	0.06	0.01	0.02	0.04							0.01	0.01		
24		1.17	2.15	3.51	0.15	0.63	1.14	0.17	0.46	0.63	0.08	0.15	0.26	0.01	0.05	0.08	0.01	0.03	0.05							0.01	0.02		
27					0.19	0.79	1.44	0.21	0.59	0.80	0.10	0.19	0.32	0.02	0.07	0.11	0.02	0.04	0.06							0.01	0.02		
30					0.23	0.98	1.77	0.26	0.73	0.98	0.12	0.23	0.40	0.02	0.08	0.13	0.02	0.05	0.07	0.01	0.01	0.03			0.01	0.01			
36					0.33	1.41	2.56	0.37	1.05	1.41	0.17	0.34	0.58	0.03	0.12	0.19	0.03	0.07	0.10	0.01	0.02	0.04			0.01	0.02			
42					0.45	1.92	3.48	0.51	1.42	1.93	0.23	0.46	0.78	0.04	0.16	0.26	0.04	0.10	0.14	0.01	0.03	0.05			0.01	0.02	0.01		
48								0.66	1.86	2.52	0.30	0.60	1.03	0.05	0.21	0.34	0.06	0.13	0.18	0.01	0.04	0.07			0.02	0.03	0.01		
54								0.84	2.35	3.18	0.38	0.75	1.30	0.06	0.27	0.43	0.07	0.16	0.23	0.02	0.04	0.08	0.01	0.02	0.04	0.01	0.01		
60								1.03	2.90	3.93	0.47	0.93	1.60	0.08	0.33	0.53	0.09	0.20	0.29	0.02	0.06	0.10	0.01	0.03	0.05	0.01	0.02		
75											0.74	1.46	2.50	0.12	0.52	0.83	0.14	0.32	0.45	0.03	0.09	0.16	0.01	0.05	0.07	0.01	0.03		
90											1.06	2.10	3.60	0.17	0.75	1.19	0.20	0.45	0.64	0.05	0.12	0.23	0.02	0.07	0.10	0.02	0.04		
105											1.45	2.85	4.91	0.24	1.02	1.62	0.28	0.62	0.88	0.07	0.17	0.32	0.02	0.09	0.14	0.02	0.05		
120														0.31	1.34	2.12	0.36	0.81	1.14	0.09	0.22	0.41	0.03	0.12	0.18	0.03	0.07	0.01	
135														0.39	1.69	2.68	0.46	1.02	1.45	0.11	0.28	0.52	0.04	0.15	0.23	0.04	0.08	0.01	
150														0.48	2.09	3.31	0.56	1.26	1.79	0.14	0.34	0.65	0.05	0.19	0.29	0.05	0.10	0.01	
180																	0.81	1.82	2.58	0.20	0.50	0.93	0.07	0.27	0.41	0.07	0.15	0.02	
210																	1.10	2.47	3.51	0.27	0.68	1.27	0.09	0.36	0.56	0.09	0.20	0.02	
240																	1.44	3.23	4.58	0.35	0.88	1.65	0.12	0.48	0.73	0.12	0.26	0.03	
270																				0.45	1.12	2.09	0.15	0.60	0.93	0.15	0.33	0.04	
300																				0.55	1.38	2.58	0.18	0.74	1.15	0.19	0.41	0.04	
360																				0.80	1.99	3.72	0.27	1.07	1.65	0.27	0.59	0.06	
420																							0.36	1.46	2.25	0.37	0.81	0.09	
480																							0.47	1.90	2.94	0.48	1.05	0.11	
540																							0.60	2.41	3.72	0.61	1.33	0.14	
600																							0.74	2.97	4.59	0.75	1.65	0.17	
660																										0.91	1.99	0.21	
720																										1.08	2.37	0.25	
780																										1.27	2.78	0.29	
840																										1.47	3.22	0.34	
900																												0.39	
1000																												0.48	
1100																												0.58	
1200																												0.70	
1300																												0.82	
1400																												0.95	
1500																												1.09	

Technical information

PRESSURE DROPS

LOCALISED PRESSURE DROPS

PRESSURE DROPS DUE TO SUDDEN NARROWING, IN METRES OF WATER COLUMN

DN = Nominal pipe diameter

Di = Real internal pipe diameter

For the continuous pressure drops in the cone, consider an equivalent length of pipe with diameter DN1 equal to L.

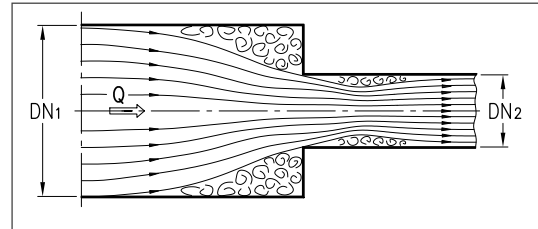

Flow rate Q [m³/h]	DN1	32		40		50		65		80		100		125		150		200		250								
	Di1	36.1	42.0	42.0	53.1	53.1	53.1	68.8	68.8	68.8	80.8	80.8	80.8	105.1	105.1	105.1	129.7	129.7	129.7	155.2	155.2	155.2	206.5	206.5	206.5	260.4	260.4	260.4
	DN2	25	25	32	25	32	40	32	40	50	40	50	65	50	65	80	65	80	100	80	100	125	100	125	150	125	150	200
	Di2	27.4	27.4	36.1	27.4	36.1	42.0	36.1	42.0	53.1	42.0	53.1	68.8	53.1	68.8	80.8	68.8	80.8	105.1	80.8	105.1	129.7	105.1	129.7	155.2	129.7	155.2	206.5
3		0,02	0,03		0,04	0,01		0,01	0,01																			
6		0,09	0,12	0,02	0,15	0,04	0,01	0,05	0,02	0,01	0,03	0,01																
9		0,19	0,26	0,04	0,34	0,08	0,03	0,11	0,05	0,01	0,06	0,02		0,02	0,01													
12		0,35	0,47	0,07	0,60	0,15	0,06	0,20	0,09	0,02	0,11	0,03	0,01	0,04	0,01													
15		0,54	0,73	0,11	0,93	0,23	0,09	0,31	0,14	0,04	0,17	0,05	0,01	0,07	0,02	0,01	0,02	0,01			0,01							
18		0,78	1,05	0,16	1,34	0,33	0,12	0,44	0,21	0,05	0,24	0,07	0,01	0,10	0,03	0,01	0,03	0,01			0,02							
21			1,43	0,22	1,83	0,45	0,17	0,60	0,28	0,07	0,33	0,10	0,02	0,13	0,04	0,01	0,05	0,02			0,02	0,01						
24			1,87	0,28	2,39	0,58	0,22	0,78	0,37	0,09	0,43	0,13	0,02	0,17	0,05	0,02	0,06	0,03	0,01	0,03	0,01			0,01				
27				0,36	3,03	0,74	0,28	0,99	0,47	0,12	0,55	0,17	0,03	0,22	0,06	0,02	0,07	0,03	0,01	0,04	0,01			0,01				
30					3,74	0,91	0,35	1,22	0,58	0,15	0,67	0,21	0,04	0,27	0,07	0,03	0,09	0,04	0,01	0,05	0,01			0,02	0,01			
36						1,31	0,50	1,76	0,83	0,21	0,97	0,30	0,05	0,39	0,11	0,04	0,13	0,06	0,01	0,07	0,02			0,03	0,01			
42							0,68	2,40	1,13	0,29	1,32	0,40	0,07	0,53	0,14	0,05	0,18	0,08	0,02	0,10	0,02	0,01	0,03	0,01		0,01		
48								3,13	1,48	0,37	1,72	0,53	0,09	0,69	0,19	0,07	0,24	0,11	0,02	0,13	0,03	0,01	0,04	0,02	0,01	0,02	0,01	
54								3,97	1,87	0,47	2,18	0,66	0,11	0,87	0,24	0,09	0,30	0,13	0,03	0,16	0,04	0,01	0,06	0,02	0,01	0,02	0,01	
60									2,31	0,58	2,69	0,82	0,14	1,08	0,29	0,11	0,37	0,16	0,03	0,20	0,05	0,01	0,07	0,02	0,01	0,03	0,01	
70									0,79	3,66	1,12	0,19	1,46	0,40	0,15	0,50	0,22	0,04	0,27	0,07	0,02	0,09	0,03	0,01	0,04	0,02		
80									4,79	1,46	2,25	1,91	0,52	0,20	0,65	0,29	0,06	0,35	0,09	0,02	0,12	0,04	0,02	0,05	0,02			
90										1,85	3,32	2,42	0,66	0,25	0,83	0,37	0,07	0,44	0,11	0,03	0,16	0,06	0,02	0,07	0,03	0,01		
105											4,43	3,29	0,90	0,34	1,13	0,50	0,10	0,60	0,16	0,04	0,21	0,08	0,03	0,09	0,04	0,01		
120												4,30	1,17	0,44	1,47	0,66	0,13	0,79	0,20	0,05	0,28	0,10	0,03	0,12	0,05	0,01		
135												5,44	1,48	0,56	1,86	0,83	0,16	0,99	0,26	0,06	0,35	0,12	0,04	0,15	0,06	0,01		
150													1,83	0,69	2,30	1,03	0,20	1,23	0,32	0,08	0,44	0,15	0,05	0,19	0,08	0,01		
165														0,83	2,78	1,25	0,24	1,48	0,39	0,09	0,53	0,19	0,07	0,23	0,10	0,02		
180															3,31	1,48	0,29	1,77	0,46	0,11	0,63	0,22	0,08	0,27	0,11	0,02		
200															4,09	1,83	0,36	2,18	0,57	0,14	0,77	0,27	0,10	0,34	0,14	0,03		
220																2,22	0,43	2,64	0,68	0,16	0,94	0,33	0,12	0,41	0,17	0,03		
240																	0,52	3,14	0,82	0,20	1,12	0,39	0,14	0,49	0,20	0,04		
260																		3,69	0,96	0,23	1,31	0,46	0,16	0,57	0,24	0,04		
280																			4,28	1,11	0,27	1,52	0,53	0,19	0,66	0,28	0,05	
300																				1,27	0,31	1,74	0,61	0,22	0,76	0,32	0,06	
330																					0,37	2,11	0,74	0,26	0,92	0,39	0,07	
370																						2,65	0,93	0,33	1,16	0,49	0,09	
410																						3,26	1,15	0,40	1,42	0,60	0,11	
450																						3,92	1,38	0,48	1,72	0,72	0,13	
500																						1,71	0,60	2,12	0,89	0,16		
550																						2,06	0,72	2,56	1,07	0,20		
600																							0,86	3,05	1,28	0,23		
660																							1,04	3,69	1,54	0,28		
720																								4,39	1,84	0,34		
780																								5,15	2,16	0,40		
840																									2,50	0,46		
900																									2,87	0,53		
960																										0,60		
1020																										0,68		

Technical information

PRESSURE DROPS

LOCALISED PRESSURE DROPS

LOCALISED PRESSURE DROPS ON DIVERGING ISO CONES, IN METRES OF WATER COLUMN

DN = Nominal pipe diameter

Di = Real internal pipe diameter

For the continuous pressure drops in the cone, consider an equivalent length of pipe with diameter DN1 equal to L.

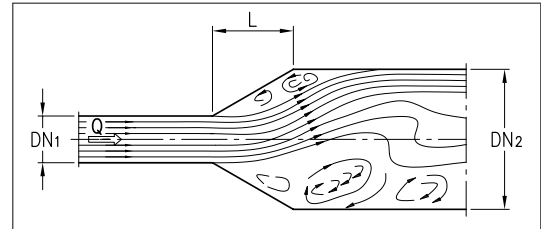

Flow rate Q [m³/h]	DN1	25			32			40			50			65			80			100			125			150			200
	Di1	28,5	28,5	28,5	37,2	37,2	37,2	43,1	43,1	43,1	54,5	54,5	54,5	70,3	70,3	70,3	82,5	82,5	82,5	107,1	107,1	107,1	131,7	131,7	131,7	159,3	159,3	206,5	
	DN2	32	40	50	40	50	65	50	65	80	65	80	100	80	100	125	100	125	150	125	150	200	150	200	250	200	250	250	
	Di2	37,2	43,1	54,5	43,1	54,5	70,3	54,5	70,3	82,5	70,3	82,5	107,1	82,5	107,1	131,7	107,1	131,7	159,3	131,7	159,3	206,5	159,3	206,5	260,4	206,5	260,4	260,4	
L	50	64	76	64	76	90	76	90	90	90	90	100	90	100	127	100	127	140	127	140	152	140	152	178	152	178	178		
3			0,01	0,02			0,01																						
6		0,01	0,03	0,07		0,01	0,03		0,01	0,02				0,01															
9		0,02	0,06	0,17		0,02	0,06		0,02	0,04			0,01	0,02															
12		0,04	0,11	0,30		0,03	0,11	0,01	0,04	0,08				0,01	0,04														
15		0,06	0,17	0,46		0,05	0,17	0,01	0,06	0,12			0,02	0,06		0,01	0,02			0,01									
18		0,09	0,24	0,66	0,01	0,07	0,25	0,01	0,08	0,17	0,01	0,03	0,09		0,01	0,03		0,01	0,02			0,01							
21		0,13	0,33	0,90	0,01	0,10	0,33	0,02	0,11	0,24	0,01	0,04	0,12		0,02	0,04		0,01	0,02			0,01							
24		0,16	0,43	1,18	0,01	0,13	0,44	0,02	0,14	0,31	0,01	0,05	0,16		0,02	0,05		0,01	0,03			0,01			0,01				
27		0,21	0,54	1,49	0,01	0,17	0,55	0,03	0,18	0,39	0,01	0,06	0,20		0,03	0,06		0,02	0,04			0,02			0,01				
30					0,02	0,21	0,68	0,03	0,22	0,48	0,02	0,07	0,25		0,03	0,07	0,01	0,02	0,05		0,01	0,02			0,01				
36					0,02	0,30	0,98	0,05	0,32	0,69	0,03	0,11	0,35		0,05	0,11	0,01	0,03	0,07		0,01	0,03			0,02				
42					0,03	0,40	1,34	0,07	0,44	0,94	0,04	0,14	0,48		0,07	0,15	0,01	0,04	0,09		0,01	0,04			0,01	0,02			
48					0,04	0,53	1,75	0,09	0,57	1,23	0,05	0,19	0,63	0,01	0,09	0,19	0,01	0,05	0,12		0,01	0,05			0,01	0,03		0,01	
54								0,11	0,72	1,56	0,06	0,24	0,80	0,01	0,11	0,24	0,02	0,07	0,16		0,02	0,07			0,01	0,04		0,01	
60								0,13	0,89	1,92	0,07	0,29	0,98	0,01	0,13	0,30	0,02	0,09	0,19		0,02	0,08			0,02	0,04		0,01	
75								0,21	1,39	3,00	0,11	0,46	1,54	0,01	0,21	0,46	0,03	0,13	0,30	0,01	0,04	0,13			0,03	0,07		0,02	
90											0,16	0,66	2,21	0,02	0,30	0,67	0,05	0,19	0,43	0,01	0,05	0,19			0,04	0,10		0,02	
105											0,22	0,90	3,01	0,03	0,41	0,91	0,07	0,26	0,59	0,01	0,07	0,26			0,05	0,13	0,01	0,03	
120														0,04	0,54	1,19	0,09	0,34	0,77	0,02	0,09	0,34	0,01	0,07	0,17	0,01	0,04		
135														0,05	0,68	1,51	0,11	0,43	0,97	0,02	0,12	0,43	0,01	0,09	0,22	0,01	0,05		
150														0,06	0,84	1,86	0,14	0,54	1,20	0,02	0,15	0,53	0,01	0,11	0,27	0,01	0,07		
180														0,08	1,21	2,68	0,20	0,77	1,73	0,04	0,21	0,76	0,01	0,15	0,39	0,02	0,10		
210																	0,27	1,05	2,36	0,05	0,29	1,03	0,02	0,21	0,53	0,03	0,13	0,01	
240																	0,35	1,37	3,08	0,06	0,37	1,35	0,02	0,27	0,69	0,03	0,17	0,01	
270																				0,08	0,47	1,70	0,03	0,34	0,88	0,04	0,21	0,01	
300																				0,10	0,59	2,10	0,04	0,42	1,08	0,05	0,26	0,01	
360																				0,14	0,84	3,03	0,06	0,61	1,56	0,07	0,38	0,02	
420																				0,19	1,15	4,12	0,08	0,83	2,12	0,10	0,52	0,03	
480																							0,10	1,09	2,77	0,13	0,68	0,04	
540																							0,12	1,38	3,50	0,17	0,86	0,05	
600																							0,15	1,70	4,33	0,21	1,06	0,06	
660																											0,25	1,28	0,07
720																											0,30	1,52	0,09
780																											0,35	1,79	0,10
840																											0,41	2,07	0,12
900																											0,47	2,38	0,13
1000																													0,17
1100																													0,20
1200																													0,24
1300																													0,28
1400																													0,33
1500																													0,37

Technical information

ELECTRIC CONTROL PANELS FOR GP PRESSURE BOOSTER SETS

The electric control and regulation panels are designed to command electric pumps in pressure booster systems and to drain sump basins or water collection tanks.

It is therefore clear that the electric panel is a crucial part of the system.

PROTECTION DEGREE

This is shown as “IP”, which stands for “Ingress Protection” (i.e. the degree of protection against the penetration of materials and extraneous agents).







Standard CEI EN 60529 (protection degree of casings - IP code) permits the IP code to be used to indicate the degree of protection of electrical equipment with regards access to live parts and the penetration of water and solid foreign bodies.

The IP code is made up of 2 characteristic numbers; an additional letter can be added in cases where the protection of people against access to live parts is higher than that indicated by the first number.

Other letters can be added to give supplementary indications for the protection of people or materials. The IP protection degree must always be read number by number, not as a whole figure.

FIRST CHARACTERISTIC NUMBER









PROTECTION AGAINST THE PENETRATION OF FOREIGN BODIES AND ACCESS TO DANGEROUS PARTS

Number	Test	Description	Comment
0		No protection	
1		Protected against solid elements measuring more than 50 mm	It must be impossible to insert parts of the human body (e.g. a hand) or solid elements measuring more than 50 mm in diameter
2		Protected against solid elements measuring more than 12 mm	It must be impossible to insert fingers, or similar objects measuring up to 80 mm, or solid bodies with a diameter of more than 12 mm
3		Protected against solid elements measuring more than 2.5 mm	It must be impossible to insert wires with a diameter or thickness of more than 2.5 mm, or solid bodies with a diameter of more than 2.5 mm
4		Protected against solid elements measuring more than 1 mm	It must be impossible to insert wires or twin leads with a diameter or thickness of more than 1 mm, or solid bodies with a diameter of more than 1 mm
5		Protected against dust	The penetration of dust is not entirely excluded, but the quantity that can enter is not enough to jeopardise correct operation
6		Totally protected against dust	No dust penetration is permitted

Technical information

ELECTRIC CONTROL PANELS FOR GP PRESSURE BOOSTER SETS

SECOND CHARACTERISTIC NUMBER PROTECTION AGAINST THE PENETRATION OF WATER

Number	Test	Description	Comment
0		No protection	
1		Protected against vertical drops of water	Drops of water that fall vertically must not produce a damaging effect
2		Protected against drops of water with a maximum inclination of 15°	Drops of water that fall vertically must not produce a damaging effect when the casing is tilted by up to 15° in relation to its original position
3		Protected against rain	Rainwater falling with an angle of up to 60° from the vertical must not produce a damaging effect
4		Protected against water spray	Water sprayed onto the casing from any direction must not produce a damaging effect
5		Protected against jets of water	Water that reaches the casing from any direction via a nozzle must not produce a damaging effect
6		Protected against powerful jets of water	In the case of waves or powerful jets, the water must not penetrate the casings in harmful quantities
7		Protected against the effects of temporary immersion	It must be impossible for harmful quantities of water to penetrate the casing immersed under certain pressure and duration conditions
8		Protected against the effects of continuous immersion	The material can be submerged in water in the conditions specified by the manufacturer

Additional letter

Protection of people against access using a tool. Must only be used if:

- the effective protection against access to dangerous parts is higher than that indicated by the first characteristic number
- the only indication is that of protection against access to dangerous parts, and the first characteristic number is replaced with an X

Technical information

ELECTRIC MOTOR START-UP METHODS

DIRECT START-UP

Direct start-up is the most simple method and involves connecting the rated motor voltage directly to the stator. In general, this type of start-up is used for less powerful motors that quickly reach their running speed.

Fig. 1 illustrates the direct start-up procedure, obtained by closing connections "1".

The main disadvantage, as seen in the drawing, is the high rotor intake current at pick-up (start-up), and therefore the high level of current requested by the stator from the mains supply, creating sudden voltage drops that affect the mains itself.

The advantages are the simplicity of the equipment, a good pick-up torque, and minimum start-up time.

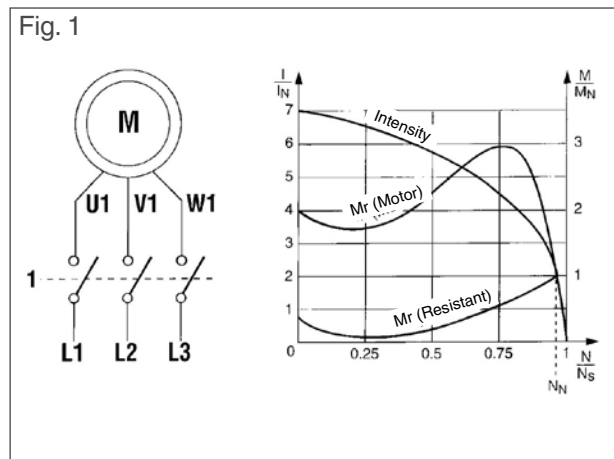

STAR – TRIANGLE START-UP (Y - Δ)

This method is used for motors that, at running speed, are powered with a triangle connection (indicated by Δ).

It involves starting the motor with the windings in a star form (Y) then, when the nominal rotation speed has almost been reached, switching them to a triangle configuration (Δ).

With reference to fig. 2, connections "2" are closed but connections "3" are left open for the star configuration, then contacts "1" are closed and the motor starts up with the star Y. In this way, the motor absorbs only $\frac{1}{3}$ of the line current required for start-up with the triangle configuration Δ. In addition, the pick-up torque is 3 times less than that with triangle start-up.

When a certain predefined speed is reached, connections "2" are opened and connections "3" are simultaneously closed to produce the triangle configuration. The torque increases (along with the intake current) compared with the Y configuration.

This method is generally used for motors with a power level between 7 and 50 kW.

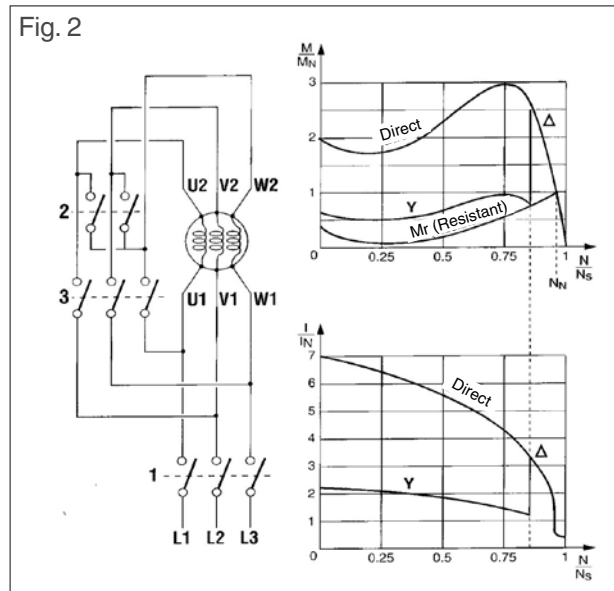

Technical information

INSTALLATION STUDY

COMBINATION OF SYSTEM SET AND WORKING POINT

To obtain the characteristic bend of two pumps or more with identical characteristics, working in parallel (SET), it is necessary - with the same head - to add together the flow rates of each single pump in the direction of the horizontal axle (i.e. the flow rate one). This is illustrated in the figure, which clearly shows that the characteristic bend of the additional pumps straightens out in comparison with that of the first pump; this causes a shift of the working point from A1 to A2 when 2 pumps are working in parallel, or to A3 in the case of 3 pumps in parallel. Of course, the characteristic bend R of the system remains unaltered.

When a set works in a system, the **working point P₀** is the intersection between the characteristic bend of the set and that of the system, as explained below.

The coordinates **H₀** and **Q₀** are respectively the head and flow rate that the set guarantees to the system during operation.

It is important to emphasise that the working point may be anywhere on the set bend depending on the shape of the characteristic bend of the system. The aim is to choose the set that not only enables the working point to guarantee the required flow rate and head, but enables it to do this with the highest possible productivity - i.e. as close as possible to the point of maximum efficiency (**BEP**).

It is taken that the working flow rate **Q₀** is **0.8÷1.1** times the BEP flow rate. For a system to function regularly therefore, the working point must be:

- in an area where the set works well (good efficiency and low NPSH field as the field within the rated points) for all the working conditions envisaged
- stable (explained in the next paragraph)

The characteristic bend of the system, and in particular the total pressure drops, must therefore be calculated carefully. An incorrect assessment of the pressure drops will cause a shift in the working point. Finally, it is worth remembering that the system pressure drops may increase over time due to encrustation in the pipes.

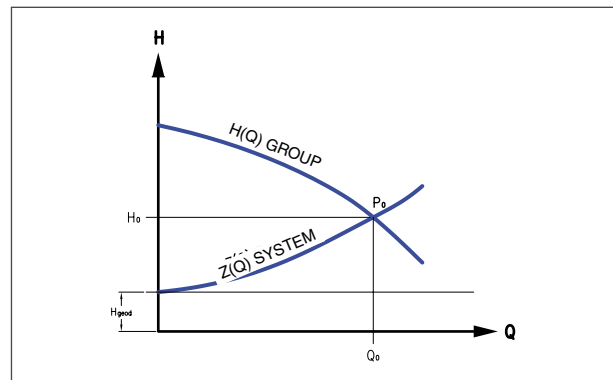
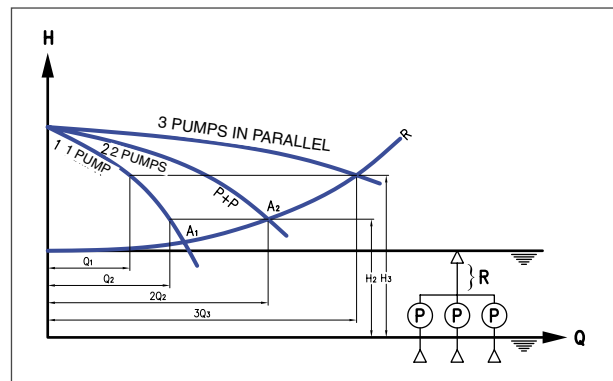

Technical information

INSTALLATION STUDY

STABILITY

For the working point to be stable, the slope of the characteristic bend **R** of the system must be greater than that of the characteristic bend **P** of the set (both evaluated on the working point considered). The greater the angle formed by the intersection of the two bends, the greater the operating stability, in that slight oscillations in the geodetic height and/or the pressure drops in the duct lead to minor flow rate variations.

For example, the working point **B** in the figure has the above-mentioned features, and so is stable. The same cannot be said for point **B2**, because an accidental increase in the pressure drops and/or the geodetic height would lead the set to work in point **B1**. Even when the initial conditions are restored, the set will not be able to return to **B2**, so the flow rate will remain at the reduced level. The disturbance cannot therefore be recovered; on the contrary, if we are in **B1** (where the slope of the characteristic bend **R** of the system is less than the characteristic bend **P** of the pump), a slight reduction in the geodetic height will produce a reduction in the flow rate rather than the increase that would be possible when starting from points **B** and **B2**.

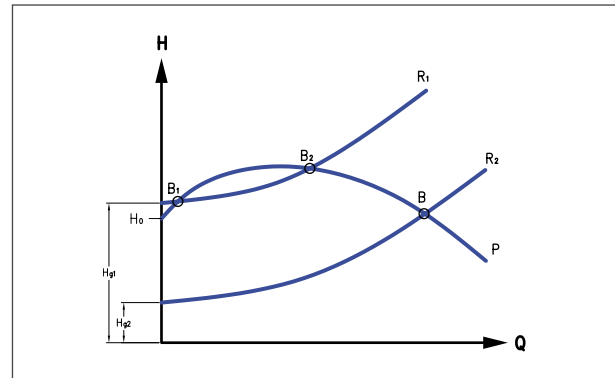

Technical information

CHOOSING THE PUMPS FOR A VARIABLE SPEED SET

GENERAL INFO

A pressure booster set is sized by analysing the trend of the flow rate demand over time (for instance over 24 hours), and by examining the distribution/usage circuit. This enables the basic parameters to be defined: Q_{max} , H_{max} , H_{set} , maximum number of pumps working, and the possible presence of a reserve (standby) pump. In any case, to optimise the use of the set, it is necessary to find the maximum flow rate point as close as possible to the bend (relating to the parallel of all the pumps working at the maximum speed). When the conditions could be critical, the NPSH must be checked in conditions with $Q_{max}-H_{max}$ - i.e. with all the pumps working. For the description of the various operating cases, the example is a set with three pumps of the same type.

CONSTANT PRESSURE SYSTEM SP EFC INVERTER DEVICES

With reference to the example in Fig. 1, it can be seen that when point $Q_{max}-H_{set}$ is not positioned on the bend relating to the parallel of all the pumps working at the maximum speed, pump 1 does not work at maximum speed when the maximum flow rate is requested. When the request diminishes, pump 1 reduces its rotation speed until it reaches a zero flow rate. At this point (M), pump 3 is stopped and pump 1 is brought to its maximum rotation speed. The variable speed pump therefore passes from zero flow rate to maximum flow rate in the tract A-B.

FIG. 1 - CHOOSING THE PUMP FOR A CONSTANT PRESSURE SET (SINGLE INVERTER)

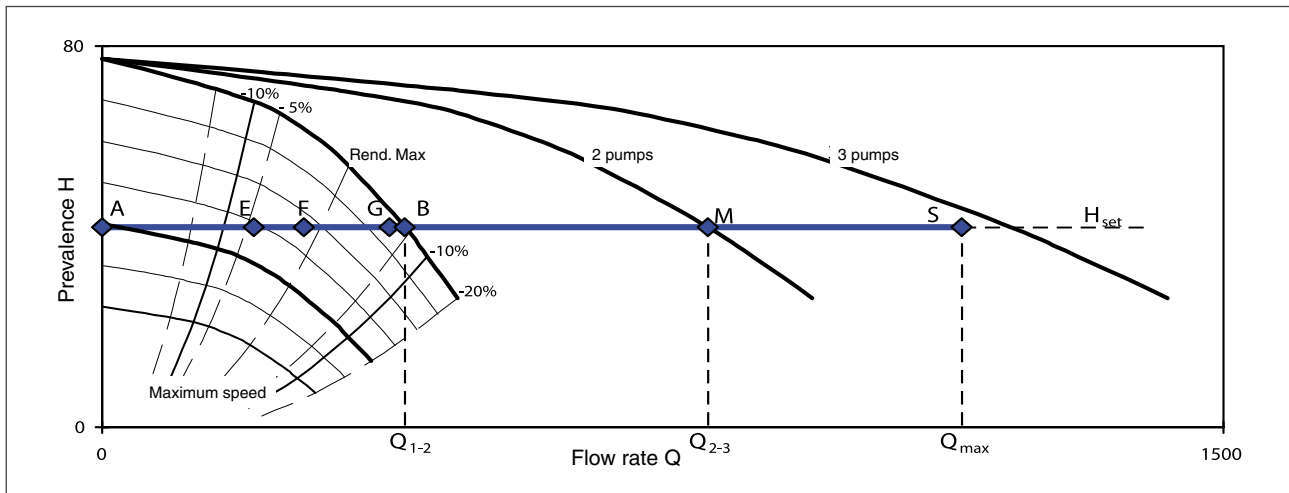
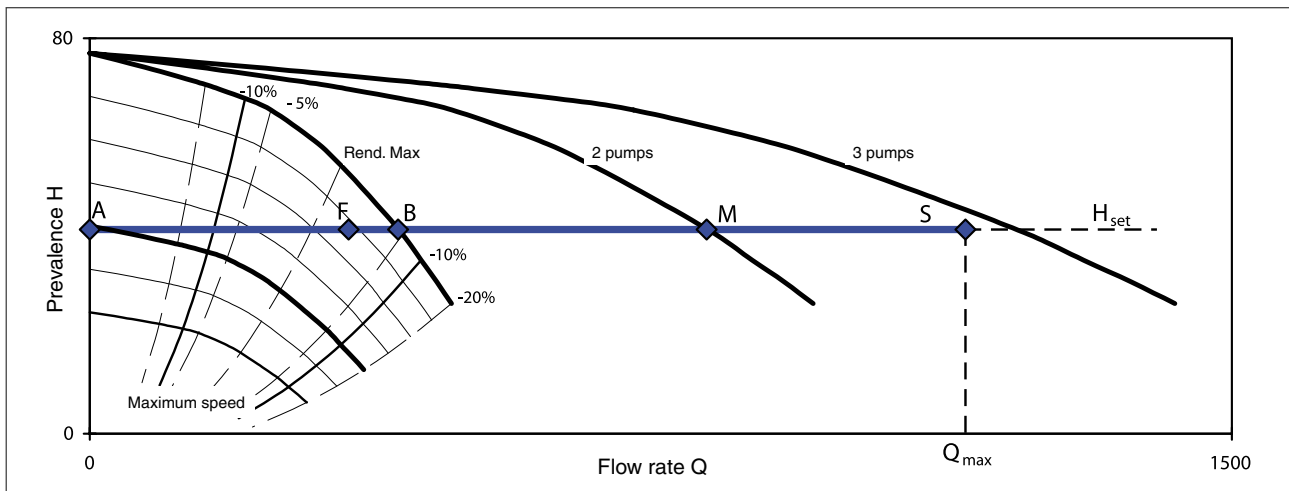

FIG. 2 - CHOOSING THE PUMP FOR A CONSTANT PRESSURE SET (MULTI-INVERTER)



Technical information

CHOOSING THE PUMPS FOR A VARIABLE SPEED SET

The pump must be selected on the basis of certain fundamental data:

- requested pressure H_{set}
- maximum flow rate that the single pump can work at (which must not be less than $Q_{max}/no. \text{ of pumps}$)

These values are used to examine the hydraulic bends of the variable speed pumps, selecting the one that covers the nominal pressure field for a flow rate that at least reaches the maximum described above. This point should be to the right of the maximum pump productivity point, but in any case ensuring a yield no lower than 5÷7% of the maximum.

CONSTANT PRESSURE SYSTEM SP MFC AND E-SPD+ INVERTER DEVICES

With reference to the example in Fig. 2, it can be seen that when point $Q_{max}-H_{set}$ is not positioned on the bend relating to the parallel of all the pumps working at the maximum speed, they all work at reduced speed even when the maximum flow rate is requested (point G seen on the single pump). When the request diminishes, pumps 1, 2 and 3 reduce their rotation speed until it reaches a Q2-3 flow rate (point F seen on the single pump). At this point (M), pump 3 is stopped and pumps 1 and 2 increase their rotation speed to adapt to the new conditions. If the request is further reduced, pumps 1 and 2 reduce their rotation speed until it reaches a Q1-2 flow rate (point E seen on the single pump). At this point (B), pump 2 is stopped and pump 1 increases its rotation speed to adapt to the new conditions. From now on, until the request terminates completely (point A), pump 1 works by itself. All the variable speed pumps therefore pass from zero flow rate to maximum flow rate in the tract A-B, but more markedly in the field E-B. The selection of the type of pump is made in the same way as for the single pump but, given the speed variation of all the pumps in the set, it is advisable to position the maximum flow rate point (B) so that its efficiency is closer to the maximum value with a deviation of less than 5%, and to also position point E so that it gives efficient values.

The selection of the pump is made in the same way as for the single pump but, given the presence of the fixed speed pumps, it is advisable to position the maximum flow rate point (B) so that its efficiency is closer to the maximum value with a deviation of less than 5%.

- Similar considerations can be made when selecting the pump in cases of stepped pressure drop compensation via pressure sets that grow with the increase in the number of pumps fitted (Fig. 3). Depending on the number of pumps fitted, pump 1 will work (modulating its speed) on tract A-B = when it works alone ($H_{set.1}$), on tract C-D = when it works in parallel with pump 2 ($H_{set.2}$), and on tract E-F = when it works in parallel with pumps 2 and 3 (H_{max}).
- Similar considerations can be made when selecting the pump in cases of stepped pressure drop compensation via pressure sets that grow with the increase in the number of pumps fitted (Fig. 4). Depending on the number of pumps working simultaneously, each of them will work (modulating their speed) on tract A-B = when pump 1 works alone ($H_{set.1}$), on tract C-D = when pumps 1 and 2 work in parallel ($H_{set.2}$), and on tract E-G = when all three pumps work in parallel (H_{max}).

CONSTANT FLOW RATE SYSTEMS

Not knowing the type of system, it is impossible to give any further indications here for the selection of the pump, apart from those given for single pumps.

MECHANICAL INSTALLATION

The set must be positioned on a flat, protected surface in an area with reserved access, where there is sufficient space for maintenance and removal. If not fitted with anti-vibration supports, the set can be anchored to the floor using foundation bolts.

- The diameter of the connection pipes must be at least equal to (no smaller than) the intake and delivery manifolds of the set; they must be as short and straight as possible and with a path that always ascends towards the pumps, using the least number of bends and avoiding goosenecks that may cause drain-traps or air pockets. You are advised to use metal pipes with a good degree of rigidity to avoid any risk of collapse.
- All the threaded or flanged connections must be well sealed to prevent air infiltration.
- Supports, anchoring systems, pipes and other system components must be independent of the set, to avoid creating additional loads or strain on it.
- It is advisable to install a shut-off valve downstream of the set.

Technical information

CHOOSING THE PUMPS FOR A VARIABLE SPEED SET

- To avoid vibrations in the system pipes, it is a good idea to install compensation joints on the intake and delivery lines of the set.
- Always install a foot valve in above-head conditions.
- When testing the set, add a T union with a shut-off valve downstream, along with the relative recirculation pipe leading to the intake tank (if the water is to be recovered).

FIG. 3 - CHOOSING THE PUMP FOR A STEPPED PRESSURE DROP COMPENSATION SET (SINGLE INVERTER)

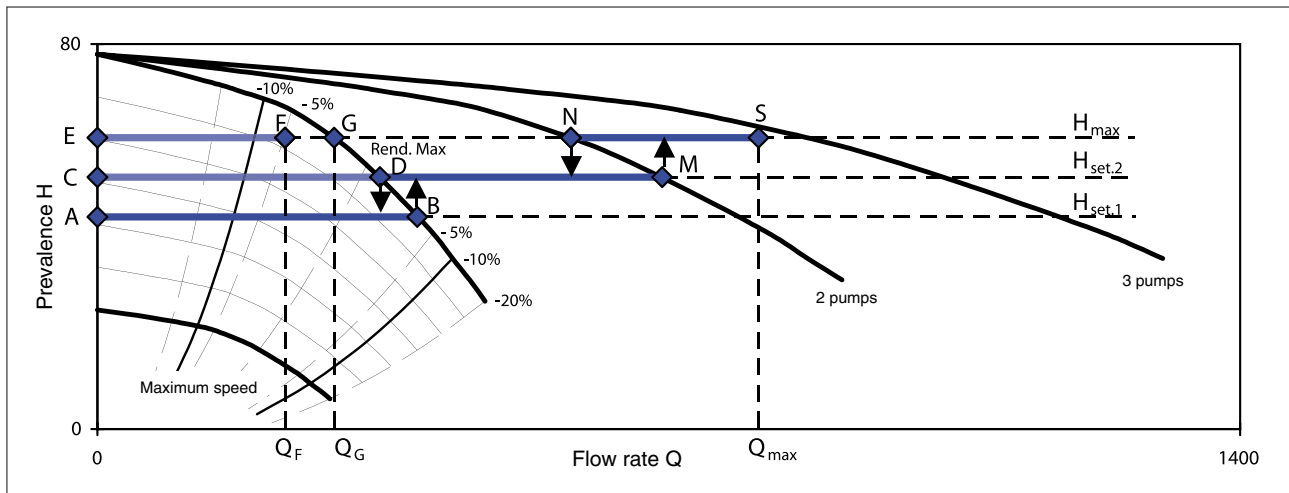
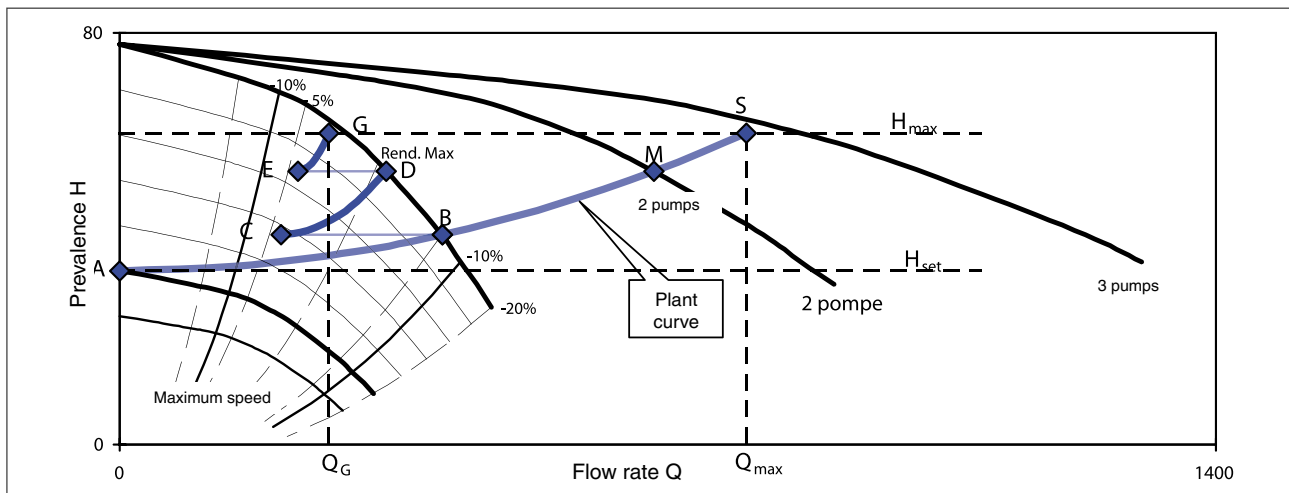

FIG. 4 - CHOOSING THE PUMP FOR A PRESSURE DROP COMPENSATION SET (MULTI-INVERTER)



Technical information

PRESSURE TANKS

CHOOSING AND SIZING THE PRESSURE TANK

The job of the pressure tank, or autoclave, is to limit the number of hourly start-ups of the pumps, supplying the system with a part of its water reserve (which is kept pressurised by the air above).

The pressure tank may be of the air cushion or membrane type. In the membrane version, an elastic membrane inside the tank itself prevents any contact between the air and the water.

In the air cushion version on the other hand, there is no marked separation between the air and the water as parts of each of them tend to mix together, so there is a need for air supply units or a compressor to divide them.

The formula for determining the volume of a pressure tank is as follows:

If we know the maximum intake of the system in litres/min (A_{max}) and the maximum number of pump start-ups permitted in one hour (N_{max}), we can use the table to calculate the necessary tank volume.



A_{max} (l/min)	System pressure												
	P_{prec}	0.8	0.8	1.8	1.3	1.3	1.8	1.8	2.3	2.3	2.3	2.8	3.8
	P_{min}	1	1	2	1.5	1.5	2	2	2.5	2.5	2.5	3	4
	P_{max}	2	2.5	3	2.5	3	2.5	4	4	4.5	5	5	8
Tank volume [litres]													
10		45	35	60	50	40	100	35	50	40	35	45	30
15		70	60	90	80	60	160	60	80	70	60	70	50
20		100	80	120	110	80	210	80	100	90	70	90	70
30		140	110	180	160	120	310	120	150	130	110	140	100
50		230	180	300	270	200	520	190	250	210	180	220	170
75		350	270	450	400	300	780	280	370	310	270	330	250
100		460	360	590	530	400	1040	370	490	410	350	440	330
150		690	540	890	790	600	1550	560	730	610	530	660	490
200		920	720	1180	1050	800	2070	740	980	810	700	870	650

The formula for making the calculation is: $V = \text{Tank} / \text{tank volume (litres)}$

A_{max} = maximum system intake (litres/min)

M = Multiplier coefficient (= 16.5 for this calculation model)

P_{min} = Minimum pressure switch setting at which the pump starts up

P_{max} = Maximum pressure switch setting at which the pump stops

N_{max} = Maximum number of pump start-ups in one hour

P_{prec} = Pre-load pressure

$$\Delta V_t = \frac{[M A_{max} (P_{max} + 1) (P_{min} + 1)]}{[N_{max} (P_{max} - P_{min}) (P_{prec} + 1)]}$$

All the pressure values are expressed in bars (relative pressure)

When calculating the volume of the tank V_f , the following parameters can be modified: N_{max} , P_{min} , P_{max} , A_{max} .

NB: adjust the tank pre-load at 0.2-0.3 bar in relation to the pump start-up pressure.

Technical information

PRESSURE TANKS

AIR CUSHION PRESSURE TANKS TECHNICAL DATA

Max operating pressure PN: 10 bar at 20°C

Max operating temperature: 50°C

Type of fluid: water

Type	Pressure tank lt.	A	B	C	D
mini	25 ÷ 500	210	66	G ½	G ½
midi	500 ÷ 2000	286	108	G ½	G ¾
maxi	2000 ÷ 4000	406	108	G ½	G ¾



$$V_m = \frac{Q_p}{4 \times Z} \times \frac{1}{1 - \frac{P_{min} - 2}{P_{max}}}$$

where:

V_m = Total volume of the air cushion pressure tank in m³

Q_p = Average flow rate of the pump in m³/h

P_{max} = Maximum calibration pressure (mca)

P_{min} = Minimum calibration pressure (mca)

Z = Maximum number of start-ups permitted by the motor in one hour

Average calibration pressure [bar]	Pressure tank capacity in litres									
	100	200	300	500	700	1000	1500	2000	2500	3000
2.5	MINI			MIDI				MAXI		
3.5	MINI			MIDI				MAXI		
4.5	MINI		MIDI				MAXI			
5.5	MINI		MIDI				MAXI			
6.5	MINI	MIDI				MAXI				
7.5	MINI	MIDI				MAXI				

HOW THE SUPPLY UNIT IS USED

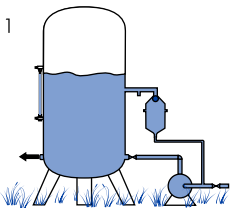

1 The electric pump is stationary. The air supply unit is full of water

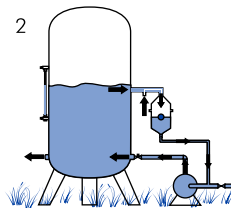

2 When the electric pump starts up, it creates a vacuum that allows the intake of the supply unit water, extracting more from the pressure tank. As it passes through the Venturi nozzle, it takes in the air from the valve

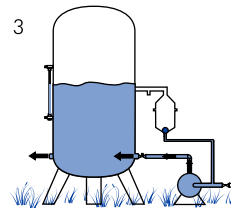

3 The water is gradually drained from the supply unit, which fills with air; the ball sits on the bottom of the unit, shutting off the connection hole to the electric pump. The supply unit is now full of air

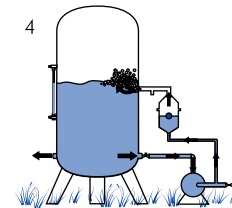

4 When the electric pump stops, the principle of communicating vessels means the supply unit air, which is lighter, moves to the upper part of the pressure tank

EBARA commercial network

EUROPE

EBARA Pumps Europe S.p.A.
Via Torri di Confine 2/1 int. C
36053 Gambellara (Vicenza), Italia
Tel +39 0444 706811
Fax +39 0444 405811
www.ebara-europe.com

Italy Sales (for orders only):
email: ordini.epe@ebara.com

Export Sales (for orders only):
email: exportsales.epe@ebara.com

Technical Customer Service (TCS):
email: tcs.epe@ebara.com
Tel +39 0444 706869/902/923/833

EBARA Pumps Europe S.p.A. GERMANY
Elisabeth-Selbert-Straße 2
63110 Rodgau, Germany
Tel +49 (0) 6106-660 99-0
Fax +49 (0) 6106-660 99-45
email: info.epde@ebara.com

EBARA Pumps Europe S.p.A. UNITED KINGDOM
Unit A, Park 34
Collett Way - Didcot
Oxfordshire - OX11 7WB, United Kingdom
Tel +44 1895 439027 - Fax +44 1235 815770
email: marketing.epuk@ebara.com

EBARA Pumps Europe S.p.A. FRANCE
122, Rue Pasteur
69780 Toussieu, France
Tel: +33 04 72 76 94 82
Fax +33 08 05 10 10 71
email: mktg.epr@ebara.com

EBARA POMPY POLSKA Sp. z o.o.
ul. Działkowa 115 A
02-234 Warszawa, Poland
Tel +48 22 3909920
Fax +48 22 3909929
email: marketing.epl@ebara.com

EBARA Pumps RUS Ltd
Prospekt Andropov 18, building 7, floor 11
115432 Moscow
Tel +7 499 6830133
email: mktg.epr@ebara.com

EBARA PUMPS IBERIA, S.A.
Poligono Ind. La Estación
C/Cormoranes 6-8
28320 Pinto (Madrid), Spain
Tel +34 916.923.630
Fax +34 916.910.818
email: marketing@ebara.es

MIDDLE EAST

EBARA Pumps Middle East FZE
P.O. BOX 61383
Jebel Ali, Dubai, UAE
Tel +971 4 8838889
Fax +971 4 8835307
email: info@ebarame.ae

EBARA PUMPS SAUDI ARABIA LLC
St. 98, Dammam Second Industrial City, P.O. Box. 9210,
Dammam 34333, Kingdom of Saudi Arabia
Tel 966-138022014

ASIA & SOUTH-EAST ASIA

EBARA Corporation
11-1, Haneda Asahi-cho, Ohta-ku,
Tokyo 144-8510, Japan
Tel +81 3 3743-6111
Fax +81 3 5736 3100
www.ebara.co.jp

EBARA Corporation Fujisawa plant
4-2-1, Hon-Fujisawa, Fujisawa-shi
Kanagawa 251-8502, Japan
Tel +81-466-83-8111
Fax +81-466-81-2164

EBARA Machinery (CHINA) CO. Ltd.
Room No.303, Beijing Fortune Plaza,
No.7 Dongsanhuan Zhong Road, Chaoyang District
Beijing, 100020 P. R. China
Tel 86-10-65309996
Fax 86-10-6530-8968
email: emc@ebara.cn
www.ebara.cn

EBARA Densan (Qingdao) Technology Co. Ltd.
No.216, Shuangyuan Road, Chengyang, Qingdao,
Shandong Province, P.R.China
Tel 86-532-8965-3369
Fax 86-532-8965-3379
www.edq-ebara.com

EBARA-Densan Taiwan Manufacturing Co. Ltd
No.7-2, Nanyuan 2nd Road, Zhongli Dist.,
Taoyuan City 320, Taiwan (R.O.C.)
Tel 886-3-451-5881
Fax 886-3-452-7904
www.ebara.com.tw

EBARA Thailand Limited
3 Fir, ACME Bldg., 125 Petchburi Road,
Thungphayathai, Rajthevee, Bangkok, 10400, Thailand
Tel 02-612-0322-30
Fax 02-612-0331
email: info.etl@ebara.com
www.ebara.co.th

EBARA Fluid Machinery Korea Co. Ltd.
6F Suam Bldg. 367, Sapyeong-daero Seocho-gu
Seoul 06541 Korea
Tel 82-2-2135-6111
Fax 82-70-8230-2030
email: sales.efmk@ebara.com
www.ebara.kr

EBARA Pumps Philippines, Inc.
Canlubang Industrial Estate,
Cabuyao 4025, Laguna, Philippines
Tel 0063-49-549-1806
Fax 0063-49-549-1915
email: marketing.eppi@ebara.com
www.ebaraphilippines.com.ph

P.T. EBARA Indonesia
Jl. Raya Jakarta - Bogor Km. 32
Desa Curug, Cimanggis-Depok
Jawa Barat, 16953 Indonesia
Tel (62-21) 874 0852-53
Fax (62-21) 874 0033
email: marketing.ptel@ebara.com
www.ebaraindonesia.com

EBARA Pumps Malaysia Sdn. Bhd
6, Jalan TP3, UEP Subang Jaya Industrial Park,
47620, Subang Jaya, Selangor, Malaysia.
Tel 603-8023 6622
Fax 603-8023 9355
email: sales.epm@ebara.com
www.ebara.com.my

EBARA Engineering Singapore Pte. Ltd.
No 1, Tuas Link 2, Singapore 638550
Tel 65-6862-3536
Fax 65-6861-0589
email: eespsales@ebara.com
www.ebara.com.sg

EBARA MACHINERY INDIA PRIVATE LIMITED
#133, 1st Floor, Velachery Main Road, Guindy,
Chennai 600 032, India
Tel 91-755-0089388

EBARA Vietnam Pump Company Limited
Lai Cach Industrial Zone, Lai Cach Town,
Cam Giang District,
Hai Duong Province, Vietnam
Tel 84-2203-850182
Fax 84-2203-850180
email: info.evpc@ebara.com
www.ebarapump.com.vn/en/

AMERICA

EBARA PUMPS AMERICAS CORPORATION
1651 Cedar Line Drive
Rockhill, South Carolina, 29730 U.S.A.
Tel 803 327-5005
Fax 803 327-5097
email: info@pumpsebara.com
www.pumpsebara.com

EBARA Bombas América do Sul Ltda
Rua Joaquim Marques de Figueiredo, 2-31,
Distrito Industrial, CEP 17034-290, Bauru, SP, Brazil
Tel +55 14 4009-0000
Fax +55 14 4009-0044
email: asistencia@ebara.com.br
www.ebara.com.br

EBARA Bombas Colombia S.A.S.
Calle 98 # 70 - 91, Oficina 1016,
Centro Empresarial Pontevedra, Bogotá - Colombia
Tel (+571) 8269865
email: ventas.ebco@ebara.com
www.ebaracolombia.com

AFRICA

EBARA PUMPS SOUTH AFRICA (PTY) LTD
26 Kyalami Boulevard, Kyalami Business Park,
1684, Midrand, Gauteng
South Africa
Tel: +27 11 466 1844
Fax: +27 11 466 1933
email: ebara.epsa@ebara.com

OCEANIA

EBARA Pumps Australia Pty. Ltd.
7, Holloway Drive
Bayswater 3153 Victoria, Australia
Tel 0061-3-97613033
Fax 0061-3-97613044
email: b.mark@ebara.com
sales@ebara.com.au
www.ebara.com.au

EZ-finder, more than just a simple selector

EZ-finder, a way to look for a model of electric pump?? **Much more.**

It is the ultimate tool to find and select the right product for your needs.

Thanks to the logic of the selector, it is possible to search for a product in **various ways**: according to the duty point, by entering the model name or by selecting the application type. **Simple**, the right product in seconds.

EZ-finder is the **ideal tool** available to the installer, the designer or the engineer.

Discover it at the link <https://ezfinder.ebara.com>





www.ebara.eu

Looking ahead,
going beyond expectations
Ahead  *Beyond*



EBARA Pumps Europe S.p.A.
Via Torri di Confine 2/1 int. C
36053 Gambellara (Vicenza), Italy
Phone +39 0444 706811
ebarapumps.epe@ebaracom
www.ebaraeurope.com

EBARA Pumps Europe S.p.A. GERMANY
Elisabeth-Selbert-Straße 2
63110 Rodgau, Germany
Phone +49 (0) 6106-660 99-0
info.epde@ebaracom

EBARA Pumps South Africa (PTY) LTD
26 Kyalami Boulevard,
Kyalami Business Park, 1684, Midrand,
Gauteng, South Africa
Phone +27 11 466 1844
ebaraeurope@ebaracom

EBARA Pumps Europe S.p.A. UK
Unit A, Park 34
Collett Way - Didcot
Oxfordshire - OX11 7WB, United Kingdom
Phone +44 1895 439027
marketing.epuk@ebaracom

EBARA Pumps Europe S.p.A. FRANCE
122, Rue Pasteur
69780 Toussieu, France
Phone: +33 04 72 76 94 82
mktg.epr@ebaracom

EBARA Pumps East Africa
Delta Corner Tower 2, 13th Floor, Office 1308,
Chiromo Road, Westlands
P.O. Box 13796-00800, Nairobi
Phone: +254(0)722913119
info.epea@ebaracom

EBARA POMPY POLSKA Sp. z o.o.
ul. Działkowa 115 A
02-234 Warszawa, Poland
Phone +48 22 3909920
marketing.epl@ebaracom

EBARA Pumps RUS Ltd.
Prospekt Andropov 18, building 7, floor 11
115432 Moscow
Phone +7 499 6830133
mktg.epr@ebaracom